

Reata Wash Flood Control Improvement Study

Contract No. 2014-168-COS

Design Concept Report Volume I - Report November 2, 2016

Prepared for:



Capital Project Management
7447 East Indian School Road, Suite 205
Scottsdale, AZ. 85251

Prepared By:

WOOD/PATEL
MISSION: CLIENT SERVICE™

Wood, Patel & Associates, Inc.
2051 West Northern Avenue, Suite 100
Phoenix, Arizona 85021

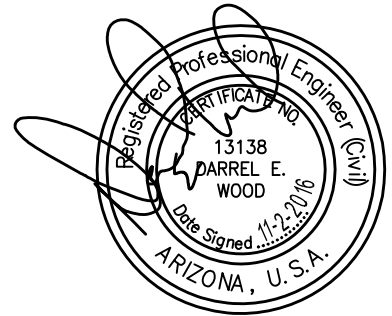

EXPIRES 12-31-16

In Association with:



THE DESIGN CONCEPT REPORT FOR THE REATA WASH FLOOD CONTROL IMPROVEMENT STUDY IS COMPOSED OF THREE SEPARATE VOLUMES:

VOLUME I – REPORT

VOLUME II – EXHIBITS

VOLUME III – APPENDICES

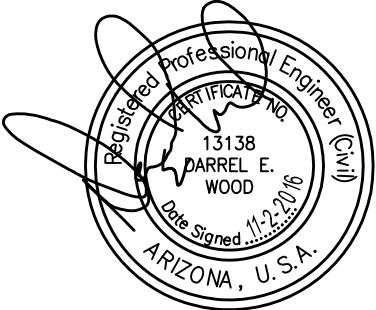

EXPIRES 12-31-16

VOLUME I
TABLE OF CONTENTS

1. EXECUTIVE SUMMARY 1

2. INTRODUCTION 5

 2.1 Authorization of Study 5

 2.2 Study Purpose and Goal 5

 2.3 Study Location 5

3. DATA COLLECTION 7

4. AGENCY COORDINATION 8

5. FLOODPLAIN FACT 12

6. PUBLIC INVOLVEMENT 14

 6.1 Public Involvement Summary: 14

 6.2 Public Involvement Goals: 15

7. ENVIRONMENTAL 17

8. LANDSCAPE 20

9. HYDROLOGY 25

10. CENTRAL ARIZONA PROJECT - FLOOD VOLUME ASSESSMENT 28

11. SEDIMENT DOCUMENTATION REVIEW AND SEDIMENT YIELD 30

12. SEDIMENT AND STABLE CHANNEL ASSESSMENT, AND GEOMORPHIC ASSESSMENT 33

13. SEDIMENT TRANSPORT AND LOCAL SCOUR ASSESSMENT 35

14. LEVEES AND LEVEE-LIKE STRUCTURES 37

15. EXISTING DRAINAGE CORRIDOR 39

16. PROPOSED DRAINAGE CORRIDOR 41

17. RECOMMENDED AND ALTERNATIVE SOLUTIONS 54

 17.1 Recommended Solution: 54

 17.2 Alternative B: 56

 17.3 Alternative C: 57

18. RIGHT OF WAY 59

19. CONSTRUCTION COST AND QUANTITIES 60

20. BENEFIT COST ANALYSIS 62

21. SUMMARY AND CONCLUSION 70

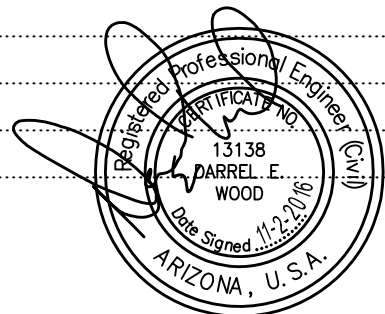

EXPIRES 12-31-16

LIST OF ACRONYMS

ADOT	Arizona Department of Transportation
ADWR	Arizona Department of Water Resources
ASLD	Arizona State Land Department
AZPDES	Arizona Pollutant Discharge Elimination System
BE	Biological Evaluation
CAP	Central Arizona Project
CEC	Categorical Exclusion Checklist
CGP	Construction General Permit
CLOMR	Conditional Letter of Map Revision
CWA	Clean Water Act
DCR	Design Concept Report
DVD	Digital Versatile Disc
EA	Environmental Assessment
EIS	Environmental Impact Statement
ESA	Endangered Species Act
FCDMC	Flood Control District of Maricopa County
FEMA	Federal Emergency Management Agency
FHWA	Federal Highway Administration
FMA	Floodplain Management Association
HEC	Hydrologic Engineering Center
HOA	Home Owner's Association
LOMR	Letter of Map Revision
NEPA	National Environmental Policy Act
NHPA	National Historic Preservation Act
NOAA	National Oceanic and Atmospheric Administration
OMRR&R	Operation, Maintenance, Remediation, Rehabilitation & Repair
SLA	Simons, Li & Associates, Inc.
SWPPP	Stormwater Pollution Prevention Plan
USACE	United States Army Corps of Engineers
USBR	United States Bureau of Reclamation
U.S.	United States

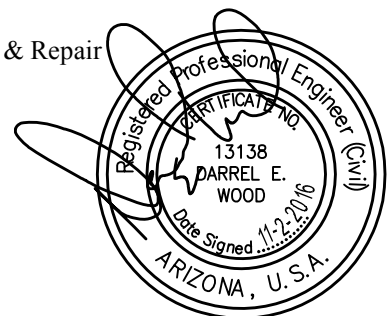

EXPIRES 12-31-16

LIST OF TABLES

Table 4.1	Meeting Coordination and Dates
Table 5.1	Land and Parcel Summary
Table 5.2	Structure Summary
Table 5.3	FEMA Flood Insurance Estimates
Table 5.4	Roadway Data
Table 9.1	Existing Conditions Peak Discharges
Table 9.2	Proposed Conditions Peak Discharges
Table 13.1	Sediment Modeling Assumption and Methods
Table 19.1	Recommend Solution
Table 20.1	Benefit Cost Ratio
Table 20.2	Cost of Flood Damage
Table 20.3	Damage Estimate for a 3500 SQ. FT. Home
Table 20.4	Annualized Cost Analysis for Various Study Elements

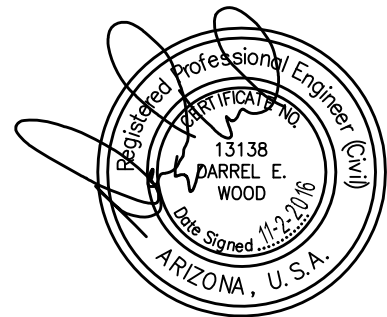

EXPIRES 12-31-16

LIST OF FIGURES

Figure 2.1	Overall Map with Floodplain
Figure 4.1	Dobson Wash Release Area (Reach 2)
Figure 8.1	Reach 1 Landscape
Figure 8.2	Reach 2 North Landscape
Figure 8.3	Reach 2 South Landscape
Figure 8.4	Reach 3 North Landscape
Figure 8.5	Reach 3 South Landscape
Figure 8.6	Reach 4 Landscape
Figure 8.7	Reach 5 Landscape
Figure 10.1	East and West Basins
Figure 11.1	Reata Wash Alluvial Fan Landform & Boundaries
Figure 14.1	Reata Wash Potential Levees (Reach 4)
Figure 16.1	Reach 1 Typical Sections
Figure 16.2	Dobson Wash Release (Reach 2)
Figure 16.3	Reach 2 Typical Sections
Figure 16.4	Reach 3 Typical Sections
Figure 16.5	Reach 4 Typical Sections
Figure 16.6	Reach 5 Typical Sections

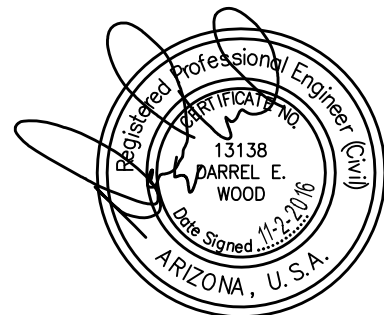

EXPIRES 12-31-16

VOLUME II
EXHIBITS

- Exhibit 1 Study Location Reach Map
- Exhibit 2 Study Location Reach Map and Existing Condition Floodplain
- Exhibit 3 Study Location Reach Map and Proposed Condition Floodplain
- Exhibit 4 Land Rights
- Exhibit 5 Concept Design Plan (15%)
- Exhibit 6 Existing Conditions Peak Discharges
- Exhibit 7 Proposed Conditions Peak Discharges

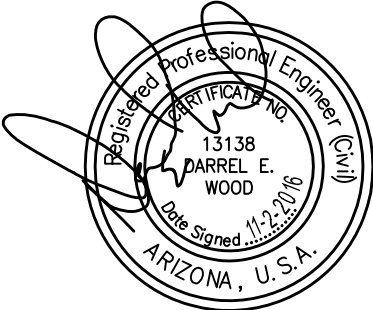

EXPIRES 12-31-16

VOLUME III
APPENDICES

Appendix A	Memorandum: Data Collection
Appendix B	Memorandum: FEMA Coordination
Appendix C	Memorandum: Floodplain Fact
Appendix D	Public Involvement Report
Appendix E	Memorandum: Environmental
Appendix F	Memorandum: Landscape Context Sensitivity Criteria
Appendix G	Memorandum: Hydrologic Review
Appendix H	Memorandum: Hydrologic Modeling
Appendix I	Memorandum: Central Arizona Project – Flood Volume Assessment
Appendix J	Memorandum: Sediment and Stable Channel Assessment: Review of Historical Documentation
Appendix K	Memorandum: Sediment and Stable Channel Assessment: Sediment Yield
Appendix L	Memorandum: Sediment and Stable Channel Assessment: Geomorphic Assessment
Appendix M	Memorandum: Sediment and Stable Channel Assessment: Sediment Transport and Local Scour Assessment
Appendix N	Memorandum: Potential Levee Identification and Assessment
Appendix O	Memorandum: Existing Condition Hydraulic Capacity
Appendix P	Memorandum: Proposed Condition Hydraulic Capacity
Appendix Q	Memorandum: Right-of-Way
Appendix R	Memorandum: Construction Cost and Quantities
Appendix S	Memorandum: Benefit Cost Analysis



EXPIRES 12-31-16

1. EXECUTIVE SUMMARY

The Reata Wash Flood Control Improvement Study (Reata Wash Study) was authorized by Scottsdale City Council on November 12, 2014. The City's consulting team was tasked with conducting a study that was proactive with stakeholders and public involvement while identifying Federal Emergency Management Agency (FEMA) compliant flood control options to support a holistic solution to mitigate the flood hazards. A byproduct of mitigating the flood hazards would be eliminating or reducing the current FEMA floodplain and its associated annual flood insurance premiums.

A FEMA compliant solution was identified and recommended (recommended solution). The recommended solution cost was determined to be \$48,210,000. This cost included the construction cost estimate (\$43,000,000), Clean Water Act (CWA) Section 404 Mitigation cost estimate (\$1,710,000), and land rights cost (\$3,500,000). The Reata Wash Study developed three alternatives using various flood control options. All options meet technical requirements identified for the Reata Wash Study. One alternative was selected and is referred to as the recommended solution. The construction costs for the recommended solution and the two alternatives are presented in Section 19.

North Scottsdale endures the burden and hazards of the Reata Wash FEMA designated floodplain. This floodplain area encompasses approximately 5,200 acres and includes approximately 4,600 structures. The Reata Wash Study's hydrologic analysis determined a FEMA compliant 100 year peak discharge at Pinnacle Peak Road Bridge of 13,015 cubic feet per second (cfs). This is an increase from the previous peak discharge (11,985 cfs) used to delineate the current regulated FEMA floodplain. The latest peak discharges reflect the updates to precipitation data published by National Oceanic and Atmospheric Administration (NOAA)-14.

An important part of the Reata Wash Study was involving the public and stakeholders via a public outreach program which included:

- Postcard mailings
- Sending emails

- Two public meetings
- Stakeholder meetings

In addition, meetings were held with federal, state and local agencies to introduce the study and request input. Meetings were held with the following agencies:

- Arizona State Land Department (ASLD)
- Central Arizona Project (CAP)
- United States Bureau of Reclamation (USBR)
- United States Army Corps of Engineers (USACE)
- Flood Control District of Maricopa County (FCDMC)
- Federal Emergency Management Agency (FEMA)

The Reata Wash Study consulting team produced 18 technical memorandums and a Public Involvement Report. An assessment of these technical factors and public involvement was required in order to recommend FEMA compliant flood control options.

The recommended solution features include:

- Use of the existing drainage channel corridor (Deer Valley Road to Bell Road)
- Use of existing public infrastructure (bridge structures at Pinnacle Peak Road, Thompson Peak Parkway, Legacy Boulevard, and Bell Road)
- Comprehensive flood control solutions that satisfy FEMA regulations
- Support for decisions compliant with anticipated environmental requirements
- Support for environment and landscape context-sensitive solutions
- Minimal land disturbance by minimizing construction footprint
- Less disruptive construction and shorter time frames to construct
- Support for design decisions for cost-effective construction

Once the components of the recommended solution were identified, the Concept Design Plan was prepared at a 15 percent design level. Once the Concept Design Plan was developed, quantity and cost-related items were estimated and included:

- Construction Quantities
- Construction Costs
- CWA Section 404 Permit Mitigation Cost
- City Land Rights Cost

The Reata Wash Study utilized a benefit cost analysis to evaluate a potential project's economic advantages (benefits) and disadvantages (costs). The end result is a benefit cost ratio, which is derived from a project's total net annualized benefits divided by its total annualized project cost. The benefit cost ratio is a numerical expression of the cost-effectiveness of a project. A project is considered to be cost-effective when the benefit cost ratio is 1.0 or greater, which indicates the benefits are greater than the cost.

Based on the annualized benefit of \$3,702,818 and annualized cost of \$1,779,354 the benefit cost ratio was determined to be 2.08, indicating the benefits of a potential flood hazard mitigation project are sufficient to justify consideration for a project.

The following represents items that were **not** accounted for in the benefit cost ratio. If these items were accounted for, it would result in a more beneficial analytical result to support a future project:

- A single 100 year flood event was used to estimate flood damages. It is noted that more frequent flood events would statistically occur over a 100 year time period
- The owners of the structures in the study area pay an approximate annual burden of \$1.8 million in FEMA flood insurance policy premiums (year 2016)
- Damages to public and private infrastructure
- Costs associated with loss of time, inconvenience and disruption of businesses
- Costs associated with injuries and loss of life

The City would also be pursuing funding partners should the Reata Wash Study be approved by City Council for advancement. Funding from other agencies would reduce the City's ultimate cost resulting in a more favorable funding scenario.

As with any potential public flood control project, land is needed to mitigate the flood hazards. It was estimated that the total city land rights needed, is approximately 292 acres. Of the 292 acres, the city has existing land rights to 279 acres (95.5%). The city would need land rights from nine property owners representing 13 acres (4.5%).

2. INTRODUCTION

2.1 Authorization of Study

The Scottsdale City Council authorized the Reata Wash Flood Control Improvement Study (Reata Wash Study) under contract 2014-168-COS, on November 12, 2014.

2.2 Study Purpose and Goal

City of Scottsdale (City) has an ongoing flood control management program that routinely identifies areas of flood hazards and community concern. When an area is believed to benefit from a reduction of floodplain hazards, a study is often recommended.

The Reata Wash Study goal is to identify a solution that addresses citizen input, cost-effectively reduces the FEMA floodplain and achieves FEMA compliance. A successful solution would reduce the potential for flood hazards and remove a significant number of residential and commercial structures from the FEMA floodplain. The current Reata Wash alluvial floodplain encompasses approximately 5,200 acres that affects approximately 4,600 structures as shown in Figure 2.1.

2.3 Study Location

The study area is located in north Scottsdale. The study drainage corridor originates approximately 1,000 feet north of Pinnacle Peak Road and extends downstream to the CAP canal, for a distance of approximately 5.3 miles. The study corridor is located along the eastern border of FEMA's 100 year floodplain. A portion of the study corridor follows the existing drainage corridor path commonly referred to as the Reata Wash alignment. The drainage corridor alignment as shown in Figure 2.1 was divided into five reaches to best represent undeveloped land features, built drainage infrastructure, and overall terrain conditions, as shown in Volume II, Exhibit 1 – Study Location Reach Map, described as follows:

- Reach 1: From 1000 ft. north of Pinnacle Peak Road Bridge to Pinnacle Peak Road Bridge
- Reach 2: From Pinnacle Peak Road Bridge to Deer Valley Road Alignment
- Reach 3: From Deer Valley Road Alignment to Thompson Peak Road Bridge
- Reach 4: From Thompson Peak Road Bridge to Bell Road Bridge
- Reach 5: From Bell Road Bridge to the CAP

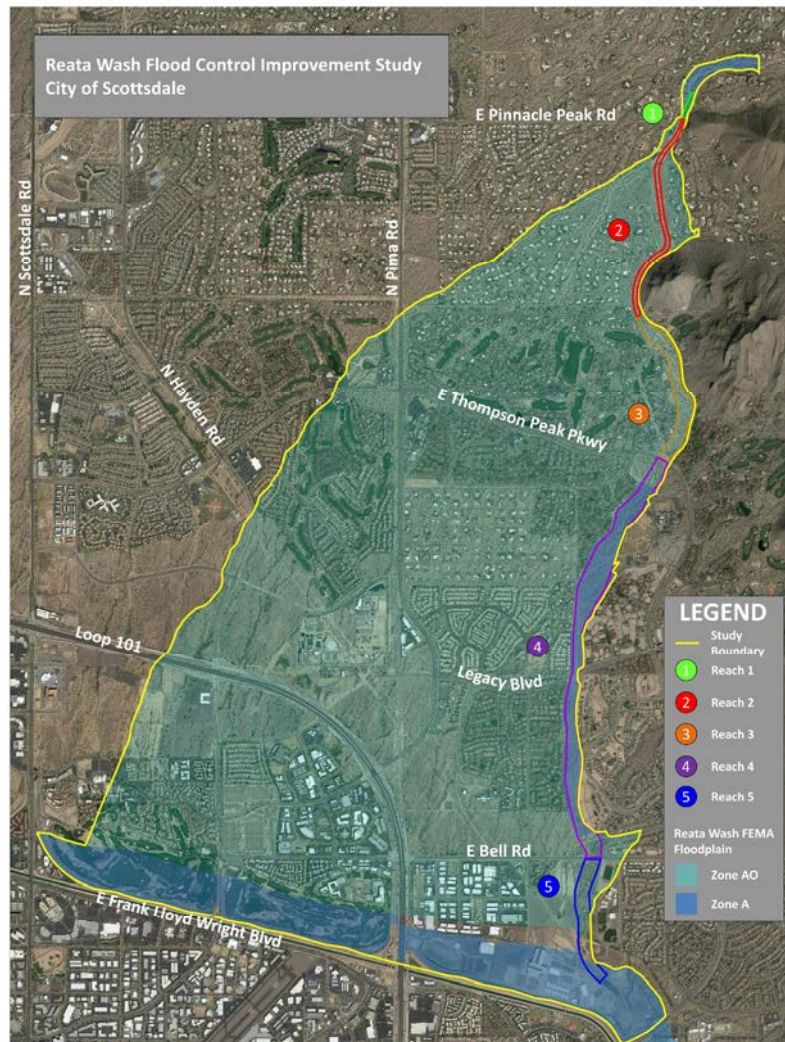

Figure 2.1 Overall Map With Floodplain

3. DATA COLLECTION

Various data was collected, reviewed and documented through the course of the Reata Wash Study. The information was obtained from research of public records or provided by agencies (see Volume III, Appendix A). The following agencies were contacted for information:

- CAP
- USBR
- USACE
- FCDMC
- FEMA
- City
- Maricopa County Assessor

The Memorandum: Data Collection (prepared by JE Fuller/Hydrology & Geomorphology, Inc.) is found in Appendix A of Volume III of the Design Concept Report (DCR).

All appendices in Volume III are provided on a Digital Versatile Disc (DVD).

4. AGENCY COORDINATION

Meetings were held with federal, state and county agencies to introduce the study and request any input or concerns the agency may have. Meetings occurred with representatives of the following agencies:

- ASLD
- CAP
- USBR
- USACE
- FCDMC
- FEMA

A critical component of the Reata Wash Study was identifying agency regulations and requirements. Numerous design decisions are required to be FEMA compliant in the removal or reduction of the current 5,200 acre FEMA designated floodplain. This led to multiple meetings with their representatives.

At a February 9, 2015 meeting, the study on objectives and schedule were introduced and discussed to familiarize FEMA staff. Then on September 9, 2015, a meeting was held that included local, regional and national representatives from Atkins Global (FEMA Region 9's technical contractor for Conditional Letter of Map Revision (CLOMR) and Letter of Map Revision (LOMR) requests). A topic of discussion was how the study would propose addressing releases to the Dobson Wash component of the Reata Wash as shown in Figure 4.1. The release would be from the main Reata Wash channel into Dobson Wash (the local name for one of the natural flow paths on the Reata Alluvial Fan landform). The general consensus of the meeting attendees regarding the proposed Reata Wash channelization and release to Dobson Wash was that the Reata Pass Alluvial Fan would no longer have active alluvial fan flood hazard characteristics. This was due to the following:

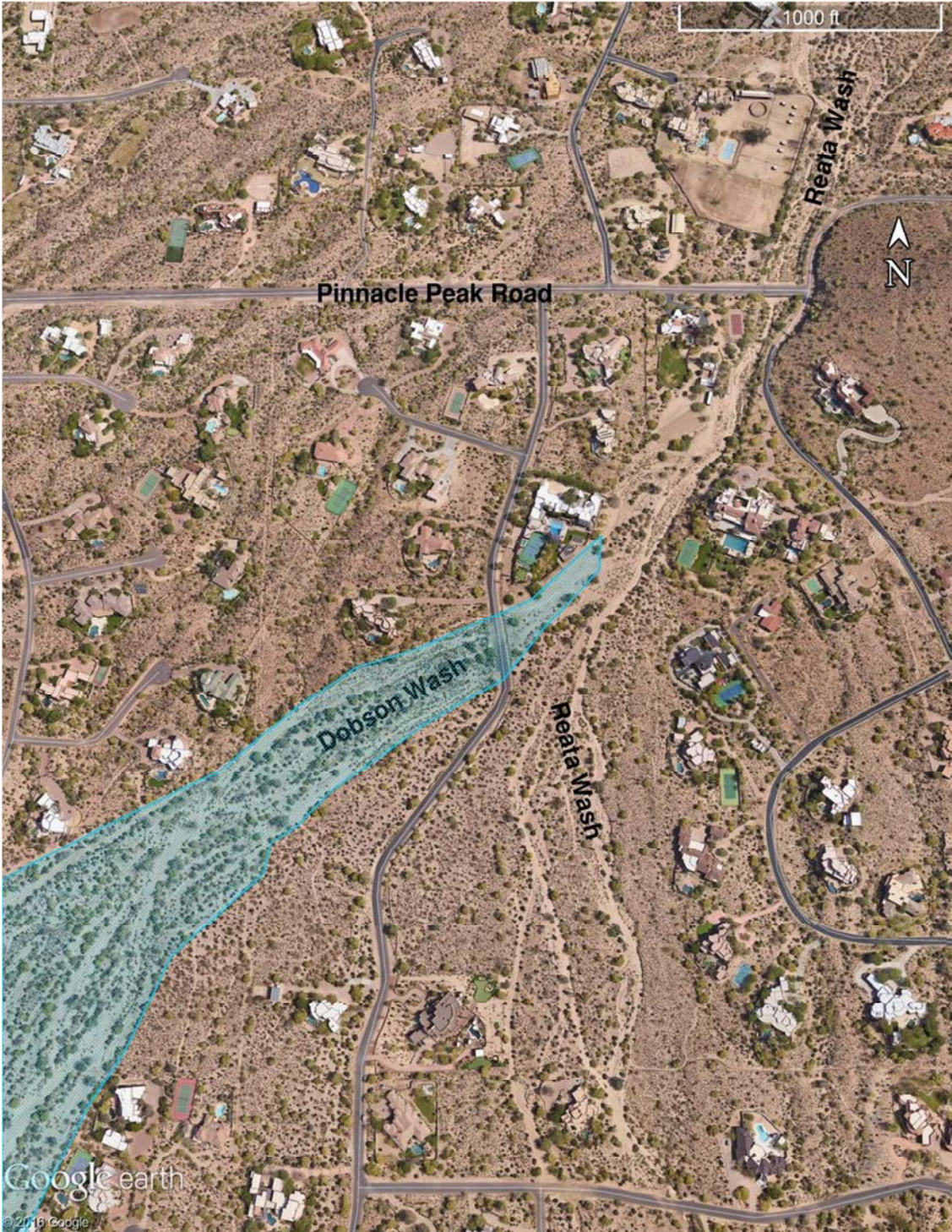

Figure 4.1 Dobson Wash Release Area (Reach 2)

-
- The majority of the full apex flow and sediment load would be contained within the proposed channel
 - The flow diverted “down-fan” along the Dobson Wash alignment would not be sufficient to cause active alluvial fan flooding or active alluvial fan landform processes
 - The flow released “down-fan” along the Dobson Wash alignment would result in a significant reduction of any flood hazard caused by flow path uncertainty along the Dobson Wash alignment

FEMA representatives noted the following:

- The Reata Wash channelization would need to prevent flow path uncertainty for the flow contained within the proposed channel
- A hydraulic analysis would be required to evaluate the depth, extent and nature of any floodplains created by flooding along Dobson Wash
- Hydraulic and geomorphic analyses would be required by FEMA as part of the Reata Wash Alluvial Fan LOMR to demonstrate that the flow released into Dobson Wash is not subject to active alluvial fan flooding (i.e., uncertain flow paths, avulsions, etc). If any flow path uncertainty or avulsion potential exists along the Dobson Wash alignment, then the floodplain delineation would be required to address this uncertainty in advance using modeling procedures approved by FEMA Region 9 staff.

In summary, agency representatives shown in Table 4.1 did not communicate any objections concerning the Reata Wash Study and its goal of finding a way to reduce flood risk.

<p>Date: February 9, 2015 Location: Tempe, AZ (JE Fuller)</p> <p>Attendance:</p> <ul style="list-style-type: none"> • Bob Bezek, FEMA Region 9 • Scott Mars, City of Scottsdale • Greg Toth, City of Scottsdale • Ash Patel, Wood, Patel • Jon Ahern, JE Fuller • Jon Fuller, JE Fuller 	<p>Date: September 9, 2015 Location: Rancho Mirage, CA Floodplain Management Association (FMA) Conference</p> <p>Attendance:</p> <ul style="list-style-type: none"> • Bob Bezek, FEMA Region 9 • Tom Sweitzer, Atkins Global • Seth Ahrens, Atkins Global • Brian Schalk, Atkins Global • Jon Fuller, JE Fuller
--	--

Table 4.1 Meeting Coordination and Dates

The Memorandum: FEMA Coordination (prepared by JE Fuller/Hydrology & Geomorphology, Inc.) is found in Appendix B of Volume III of the DCR.

All appendices in Volume III are provided on a DVD.

5. FLOODPLAIN FACT

A floodplain fact review and assessment was conducted for the Reata Wash Study (see Volume III, Appendix C). The principal focus of the assessment was to summarize data sources and provide a breakdown of categories as follows:

1. Total acreage of public and private land
2. Total commercial and residential structures
3. Estimated annual FEMA flood insurance premiums
4. Total public roadway centerline miles

The public and private land rights are summarized in Table 5.1:

Land Ownership	Area (acres)	Number of Parcels
Private	4,015	6,215
Public	1,055	92
Total	5,070	6,307

Table 5.1 Land and Parcel Summary

The types of structures are summarized in Table 5.2:

Type of Structure	Number of Structures
Commercial	206
Covered Parking	466
Detached Garage/Shed	48
Multi-Family	229
Municipal Building	59
⁽¹⁾ Other	312
Parking Garage	2
Residential	3,212
Resort	40
Secondary Dwelling	94
Total	4,668

(1) Includes miscellaneous structure types.

Table 5.2 Structure Summary

The FEMA flood insurance premiums are summarized in Table 5.3:

Type of Structure	FEMA Designated Zone	Number of Structures	Estimated Annual Premium (\$)	Estimated Total Annual Premium (\$)
Commercial	A/AO	206	1,618	333,308
Multi-Family	A/AO	229	891	204,039
Residential	A/AO	2,248	537	1,207,176
Resort	A/AO	40	1,618	64,720
Total		2,782		1,809,243

Note: Residential number represents an estimate that 70% of residential structures have flood insurance.

Zone AO: Areas subject to inundation by 1-percent-annual-chance shallow flooding (usually sheet flow on sloping terrain) where average depths are between one and three feet.

Zone A: Areas subject to inundation by the 1-percent-annual-chance flood event generally determined using approximate methodologies.

Table 5.3 FEMA Flood Insurance Estimates

The length of various classifications of roadways is summarized in Table 5.4:

Type of Roadway	Roadway Centerline Miles
Freeway	4.83
Freeway Access	3.64
Frontage Road	2.39
Major Arterial	3.51
Major Collector	2.83
Minor Arterial	8.94
Minor Collector	1.84
Neighborhood Arterial	2.58
Private	30.62
Residential	32.83
Total	94.01

Table 5.4 Roadway Data

The Memorandum: Floodplain Fact (prepared by JE Fuller/Hydrology & Geomorphology, Inc.) is found in Appendix C of Volume III of the DCR.

All appendices in Volume III are provided on a DVD.

6. PUBLIC INVOLVEMENT

6.1 Public Involvement Summary:

The Reata Wash Study included an extensive Public Involvement Program. More than 300 people participated in the study by attending stakeholder, neighborhood or public meetings, submitting online comments, or providing information via e-mail and telephone calls with study team members.

6.1.1. Public Input:

Following is a summary of the opportunities for input provided to the community from January 2015 through August 2016.

- Reata Wash Flood Control Study page posted on City of Scottsdale website and updated before and after each meeting: **January 2015 - August 2016**
- Postcards Mailed to Residents: **8,412 households**
 - Postcard #1: February 2016
 - Postcard #2: May 2016
- Public Meeting #1, March 2, 2016: **91 attendees**
 - *86% of people who participated stated it was important for the City to identify potential solutions to reduce the flood risk.*
 - Question Cards Received: **23**
 - Comment Forms Received: **15 (5 Completed evaluation)**
- Public Meeting #2, May 18, 2016: **105 attendees**
 - Question Cards Received: **18**
 - Comment Forms Received: **10 (9 Evaluated at least one option)**
 - Online Comments: **15**
- Study E-mail Distribution List: **226 e-mail addresses**
- Stakeholder Meetings: **18 meetings**
- Resident/HOA Meetings and Phone Calls: **13 meetings and 2 phone calls**

- *Residents who attended the HOA briefings were supportive of the study and the need to reduce the flood risk.*
- HOAs Offered Briefings but Declined: **9**
- HOAs Accepted Information to Distribute to Residents: **19**

6.2 Public Involvement Goals:

- Create awareness of the study and opportunities for input and involvement
- Provide information on the potential for structures flooding in the Reata Wash floodplain
- Ask if residents felt the risk was high enough to pursue flood mitigation
- Obtain feedback on which options residents would prefer if flood mitigation occurred

6.2. Input Received:

6.2.1. Public Meeting #1 – March 2, 2016

The purpose of the first meeting was to inform the community of the study purpose and need, flood risks, limitations, and overall approach for mitigation. In addition, the team sought community consensus on the need for flood mitigation.

Most attendees believed it is important for the City to develop potential options to reduce flood risk and reduce or eliminate the need for flood insurance currently required by FEMA regulatory requirements for the current effective flood hazard zones. This is based on responses on the comment forms received, responses to an interactive poll conducted during the first public meeting, and feedback received during neighborhood and stakeholder meetings.

- The majority – 82% of comment form responses and 86% of interactive poll responses at the public meeting – indicated it is very important or somewhat important to develop options to reduce flood risk.
- Key reasons given for identifying options to reduce the flood risk included:
 - Protecting life and property
 - Reducing flood insurance costs to property owners in the floodplain

- Key reasons given for NOT identifying options to reduce the flood risk included:
 - Belief that the FEMA floodplain is inaccurately mapped
 - Belief that homes in the floodplain are elevated and not at risk of flooding
 - Desire to not have concrete structures
 - Desire to leave the wash in its natural state
- A vocal contingent of residents believes the area is not at risk of flooding and do not support construction of new flood control infrastructure.

6.2.2. Public Meeting #2 – May 18, 2016

The purposes of the second meeting were to present flood control options and determine which are acceptable to the community.

Overall, there is more community support than opposition for a flood control solution for Reata Wash. Study supporters are generally in communities within reaches 3, 4 and 5. Those who oppose the study are residents in communities within reaches 1 and 2. Opponents are homeowners whose properties are adjacent to or near the wash and are concerned about direct property impacts.

The Public Involvement Report (prepared by Gunn Consultants, Inc.) is found in Appendix D of Volume III of the DCR.

All appendices in Volume III are provided on a DVD.

7. ENVIRONMENTAL

A review of environmental regulations, environmental resources, and anticipated agency involvement relevant to the Reata Wash Study was conducted. Results included summarizing the environmental background research and preliminary agency coordination of the Reata Wash Study's environmental elements.

The Reata Wash Study presents a recommended solution which involves existing and proposed flood control improvements which may result in federal actions (e.g., permit approvals, funding, etc.) by the following agencies:

- USBR
- FEMA
- USACE

Therefore, compliance with federal environmental regulations such as the National Environmental Policy Act (NEPA), CWA, Endangered Species Act (ESA), and the National Historic Preservation Act (NHPA) is anticipated. For actions that involve multiple federal agencies, a common approach is for a single federal agency to act as a lead, or for the multiple agencies to act jointly or cooperatively. However, each agency that conducts a federal action would continue to require compliance with their agency-specific NEPA requirements. Each level of NEPA analysis for each agency varies in the magnitude of required documentation and evaluation, including agency scoping, public involvement, and technical resource studies (e.g., biological and cultural resource evaluations).

Based on previous and ongoing coordination between the City and the applicable federal agencies, as well as the site-specific environmental conditions and the flood control improvements as described in the Reata Wash Study, the following NEPA documentation is anticipated:

- USBR: a Categorical Exclusion could be needed if flood control improvements occur within Reach 5, as portions of Reach 5 are owned by the USBR. Preparation of a USBR Environmental Assessment (EA) or Environmental Impact Statement (EIS) is not

anticipated, but would be determined by USBR upon completion of the Categorical Exclusion Checklist (CEC).

- FEMA: if federal funds through FEMA are used for the design and/or construction of the flood control improvements, a FEMA EA would likely be required. If FEMA funding is not used, the FEMA NEPA process would not apply.
- USACE: a CWA Section 404 Individual Permit is anticipated to be needed for the proposed project due to the level of impacts to waters of the U.S. that would be caused by the installation of the proposed flood control improvements. USACE approval of an Individual Permit requires project compliance with USACE NEPA process. The USACE's CWA Section 404 Individual Permit application includes preparation of a *Department of the Army Environmental Assessment and Statement of Finding*, which serves as the USACE's EA for compliance with the USACE NEPA process.

The City has met with USBR and the USACE to discuss potential environmental concerns within the Reata Wash Study Area and the agency-specific environmental documentation that should be anticipated for the potential flood control improvements. Based on these discussions, it should be anticipated that the USACE would be the lead federal agency for improvements within the overall Reata Wash Study Area. USBR, and potentially FEMA, would likely act as either a joint lead or cooperating agency, and the NEPA process would be documented according to the USACE's EA and Statement of Findings.

Since the proposed flood control improvements are anticipated to cause permanent and temporary impacts to Waters of the U.S. under jurisdiction of the USACE, compliance with CWA Sections 401, 402, and 404 would be required. Based on the estimated level of impacts to Waters of the U.S. from the proposed flood control improvements, a CWA Section 404 Individual Permit and a CWA Section 401 individual water quality certification are anticipated to be needed. Additionally, since more than 1 acre of land would likely be disturbed during construction activities, an Arizona Pollutant Discharge Elimination System (AZPDES) Construction General Permit (CGP) with an associated stormwater pollution prevention plan (SWPPP) would be required.

Based on the presence of potential Waters of the U.S. within the Reata Wash Study Area and the anticipated need for a CWA Section 404 permit, the submittal of a Preliminary or

Approved Jurisdictional Delineation to the USACE would be required to document the locations and extent of potentially jurisdictional Waters of the U.S.. The CWA Section 404 Individual Permit that is anticipated to be needed would require demonstration that the proposed improvements minimized or avoided impacts whenever practicable. Any impacts that cannot be avoided may be subject to compensatory mitigation as determined by the USACE.

Preparation of a Biological Evaluation (BE) is anticipated to be needed to support the agency-specific environmental compliance documents for the construction of flood control improvements within the Reata Wash Study Area. The BE should evaluate potential impacts to special status species, including those protected under the ESA. Improvements within the immediate channel bottom of Reata Wash (including those related to drop structures, culverts, dissipaters, and inlet/outlet structures) should also allow for continued wildlife movement upstream and downstream of any structure to maintain north-south wildlife movement through the Reata Wash corridor.

Based on a review of previous cultural resource survey documentation, the majority of the Reata Wash Study Area has been surveyed for cultural resources, and sites determined eligible for inclusion in the National Register of Historic Places are present. Should the Reata Wash Study be approved by City Council for advancement, it is recommended that the location of potential improvements be reviewed with respect to the results of the Class I research to determine the need for additional cultural resource survey and reporting. Depending on the location of potential improvements and associated ground disturbance, a new Class III survey may be needed in portions of the Reata Wash Study Area where previously conducted surveys do not meet current standards or where survey has not yet been completed.

The Memorandum: Environmental (prepared by Logan Simpson Design.) is found in Appendix E of Volume III of the DCR.

All appendices in Volume III are provided on a DVD.

8. LANDSCAPE

Should the Reata Wash Study be approved by City Council for advancement, it would utilize a context sensitive design approach. Context sensitive design is a collaborative, interdisciplinary approach that involves all stakeholders to develop a design that fits a project's physical setting and preserves scenic, aesthetic and environmental resources.

The Reata Wash Study implemented a context sensitive design approach to integrate a potential project in harmony with the existing landscape and community context for each of the five study reaches including:

- Landscape methodology
- Compliance with City of Scottsdale Native Plant Ordinance requirements
- Revegetation methodology
- Landscape summaries of each reach

Context sensitive design is an approach that considers the total context within which the Reata Wash Study area would exist by incorporating community values, physical needs and natural environment as an integral part of any future design.

The existing landscape along the entire alignment consists primarily of native upper Sonoran Desert plant materials typified by Foothill Palo Verde, Ironwood and Mesquite trees, saguaro, barrel, prickly pear and cholla cacti, Jojoba, Creosote, burr sage and brittlebush perennial shrubs and native grasses. It is anticipated that there would be areas adjacent to the proposed channel that may be disturbed if channel construction occurs. These disturbed areas would be revegetated to reestablish the natural desert conditions consistent with existing conditions. The ultimate goal would be to reestablish the native desert vegetation and appearance to facilitate landscape transitions that would blend into the adjacent undisturbed desert. This would be accomplished through a process of native revegetation including the planting and transplanting of native trees and cacti salvaged from onsite and the installation of a native hydroseed mix throughout the entire zone of disturbance.

The typical context sensitive native plant vegetation proposed for each reach for the three alternative solutions identified in this study (the Recommended Solution, Alternative B and Alternative C) are represented as shown in Figures 8.1 through 8.7.

REACH 1



Figure 8.1 Reach 1 Landscape

REACH 2 NORTH

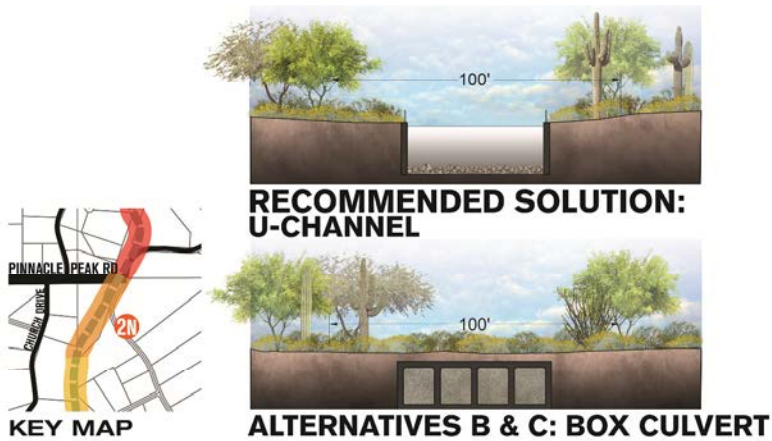
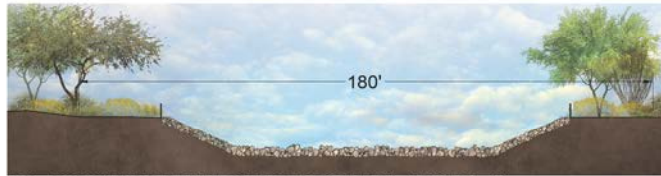
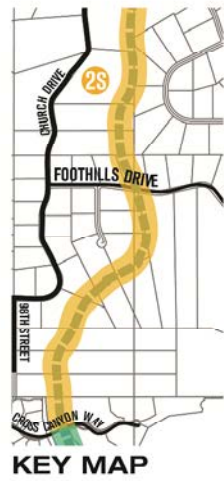
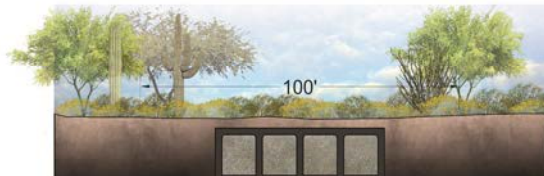

Figure 8.2 Reach 2 North Landscape

REACH 2 SOUTH



RECOMMENDED SOLUTION & ALTERNATIVE B: GROUTED ROCK CHANNEL



ALTERNATIVES C: BOX CULVERT

Figure 8.3 Reach 2 South Landscape

REACH 3 NORTH

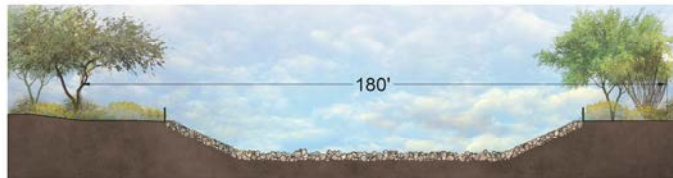
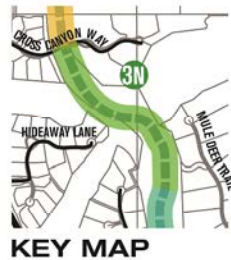

RECOMMENDED SOLUTION & ALTERNATIVE B: GROUTED ROCK CHANNEL

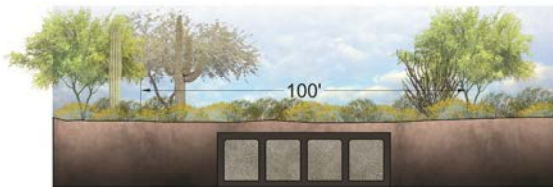

ALTERNATIVES C: BOX CULVERT

Figure 8.4 Reach 3 North Landscape

REACH 3 SOUTH

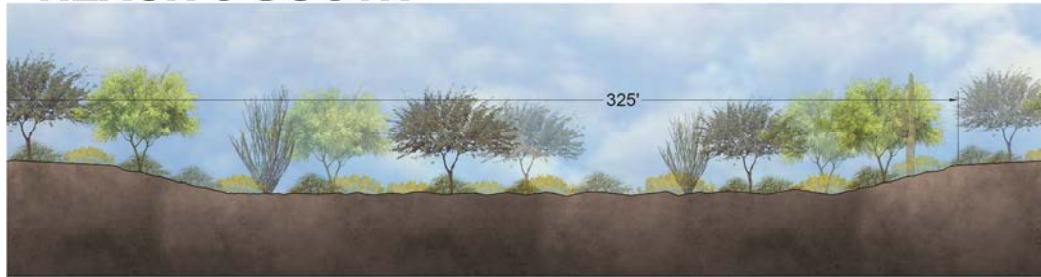

EXISTING EARTHEN CHANNEL TO REMAIN

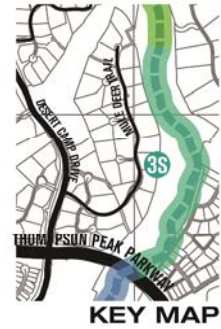
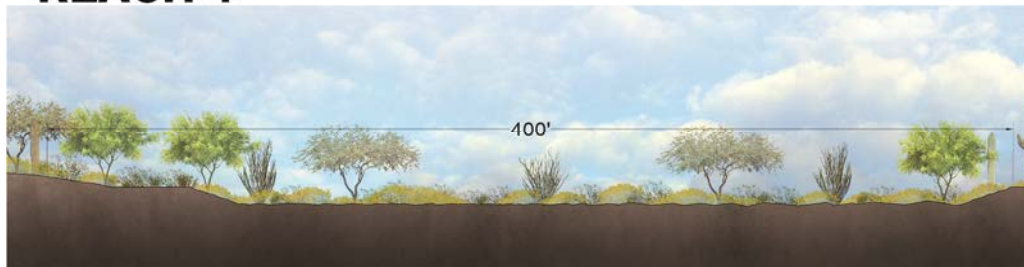

Figure 8.5 Reach 3 South Landscape

REACH 4



EXISTING EARTHEN CHANNEL TO REMAIN



Figure 8.6 Reach 4 Landscape

REACH 5

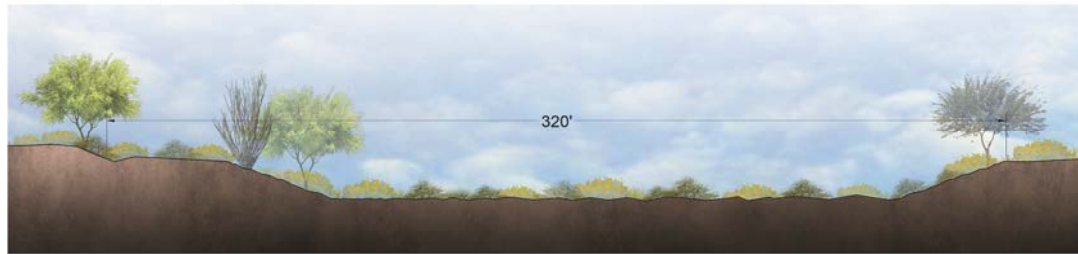

EARTHEN CHANNEL WITH REVEGETATION AND DUST CONTROL PALLIATIVE



Figure 8.7 Reach 5 Landscape

The Memorandum: Landscape Context Sensitivity Criteria (prepared by Floor Associates.) is found in Appendix F of Volume III of the DCR.

All appendices in Volume III are provided on a DVD.

9. HYDROLOGY

A review and assessment of existing hydrologic reports and models pertinent to the Reata Wash Study area was conducted (see Volume III, Appendices G and H). The purpose of this review was to determine the applicability of the existing hydrologic models to the current study, as well as assess the need for alterations and updates. Although a large portion of the historical hydrologic models meet the minimal FEMA requirements, the Draft Pinnacle Peak South Area Drainage Master Study Hydrology and Hydraulics Report model, prepared by TY Lin International (TY Lin) in 2012, was evaluated and advanced as the most appropriate hydrologic model for the following reasons:

- Most recent hydrologic modeling effort within the Reata Wash watershed
- Hydrologic model used current FCDMC standards and methods. Model includes updated land use, soils and hydrologic basin boundaries accounting for existing watershed conditions
- Hydrologic model and model input data reviewed extensively by FCDMC staff
- Hydrologic model covers approximately 85% of the Reata Wash 19.6 square mile watershed and would require less effort to adjust for the Reata Wash corridor

The following modifications were incorporated into the Draft Pinnacle Peak South Area Drainage Master Study hydrologic model for use in the Reata Wash Study:

- Land use categories and boundaries within the model limits were checked against aeriels (2014) and flood control facilities not currently existing or under construction were removed from the hydrologic model
- The watershed boundaries were extended to include the Reata Wash Corridor from Pinnacle Peak Road south to Bell Road. This area is approximately 1.6 square miles of the 2.0 square mile Reata Wash major basin
- A full review of the input parameters was conducted as part of the Reata Wash Study

The updates and adjustments to the Draft Pinnacle Peak South Area Drainage Master Study hydrologic models described above are documented (see Volume III, Appendix H). The study resulted in the development of rainfall-runoff models for the 2-year, 5-year, 10-year,

25-year, 50year, and 100-year events of 24-hour duration for the watershed. Existing condition peak discharges and proposed peak condition discharges are displayed as shown in Table 9.1 and Table 9.2 respectively.

Existing Conditions Peak Discharges		
Project Control Line Station		100-yr, Peak Flow (cfs)
Upstream	Downstream	
306+00	260+00	13,015
260+00	235+00	12,867
235+00	186+00	13,371
186+00	173+00	13,063
173+00	151+00	14,483
151+00	134+00	14,271
134+00	117+77	14,059
117+77	67+00	13,847
67+00	16+00	17,345

Table 9.1 Existing Conditions Peak Discharges

Proposed Conditions Peak Discharges		
Project Control Line Station		100-yr, Peak Flow (cfs)
Upstream	Downstream	
306+00	284+00	13,015
284+00	261+00	11,015
261+00	232+00	11,340
232+00	222+00	11,254
222+00	173+00	11,901
173+00	151+00	12,338
151+00	134+00	12,182
134+00	117+77	12,026
117+77	66+00	11,870
66+00	23+30	15,842

Table 9.2 Proposed Conditions Peak Discharges

The Existing Conditions Peak Discharges are as shown in Volume II, Exhibit 6, the Proposed Conditions Peak Discharge are as shown in Volume II, Exhibit 7.

The Memorandum: Hydrologic Review (prepared by JE Fuller Hydrology & Geomorphology, Inc.) is found in Appendix G of Volume III of the DCR.

The Memorandum: Hydrologic Modeling (prepared by JE Fuller Hydrology & Geomorphology, Inc.) is found in Appendix H of Volume III of the DCR.

All appendices in Volume III are provided on a DVD.

10. CENTRAL ARIZONA PROJECT - FLOOD VOLUME ASSESSMENT

An assessment was conducted to compare the runoff volume from the Reata Wash Study updated hydrologic modeling to historical design flood volumes for the CAP Reach 11 basins (see Volume III, Appendix I). The volume comparison assumed hydrologic models with full apex flows using historic elevations/volume data specific to the design volumes for CAP Reach 11, Dike 4, (East and West Basins) as shown in Figure 10.1. Using previously established elevation/volume relationship and comparing to Reata Wash Study results indicated similar elevations. Sediment volume was not considered for the overall basin volume comparison due to the maintenance agreement between the USBR and the City (WestWorld). Per the agreement, the City assumes responsibility for not allowing sediment to accumulate in Basin 4 West.

Historic retention volumes and elevations for Dike 4 (East and West Basins) were determined. Due to the uncertainty of where these flows will go from storms larger than the 100-year event, it was conservatively assumed that 100 percent of the flood event would contribute to each dike, Dike 3 (Basin 3) and Dike 4 (East and West Basins), for all flood events. The volume of runoff from the Reata Wash Study updated hydrologic model included volume adjustments for Dike 4 contributing area. This volume was investigated and found to result in an approximate elevation of 1,528.4 feet (mean sea level) using a volume/elevation relationship. This resulting elevation falls within the limit of the historic Dike 4 West Basin elevations and is very close to the statistical mean of the elevations reported in the original design documents of 1527.5 feet (Reference A), 1528.1 feet (Reference B) and 1529.0 feet (Reference C and D) (see Volume III, Appendix I).

- Reference A: USBR and Arizona State Land Department (ASLD) documents 1990-1991 scanned from files at the City
- Reference B: WestWorld Golf Course, Desert Greenbelt, Management – Operation Plan, not dated
- Reference C: Letter from Bob Ward (Consulting Engineer) to the City of Scottsdale; Subject Floodpool Analysis, CAP Detention Basin No. 4. May 20, 1996.
- Reference D: Letter from Bob Ward to the City of Scottsdale; Subject Updated Floodpool Analysis, CAP Detention Basin No. 4. June 1, 1996.

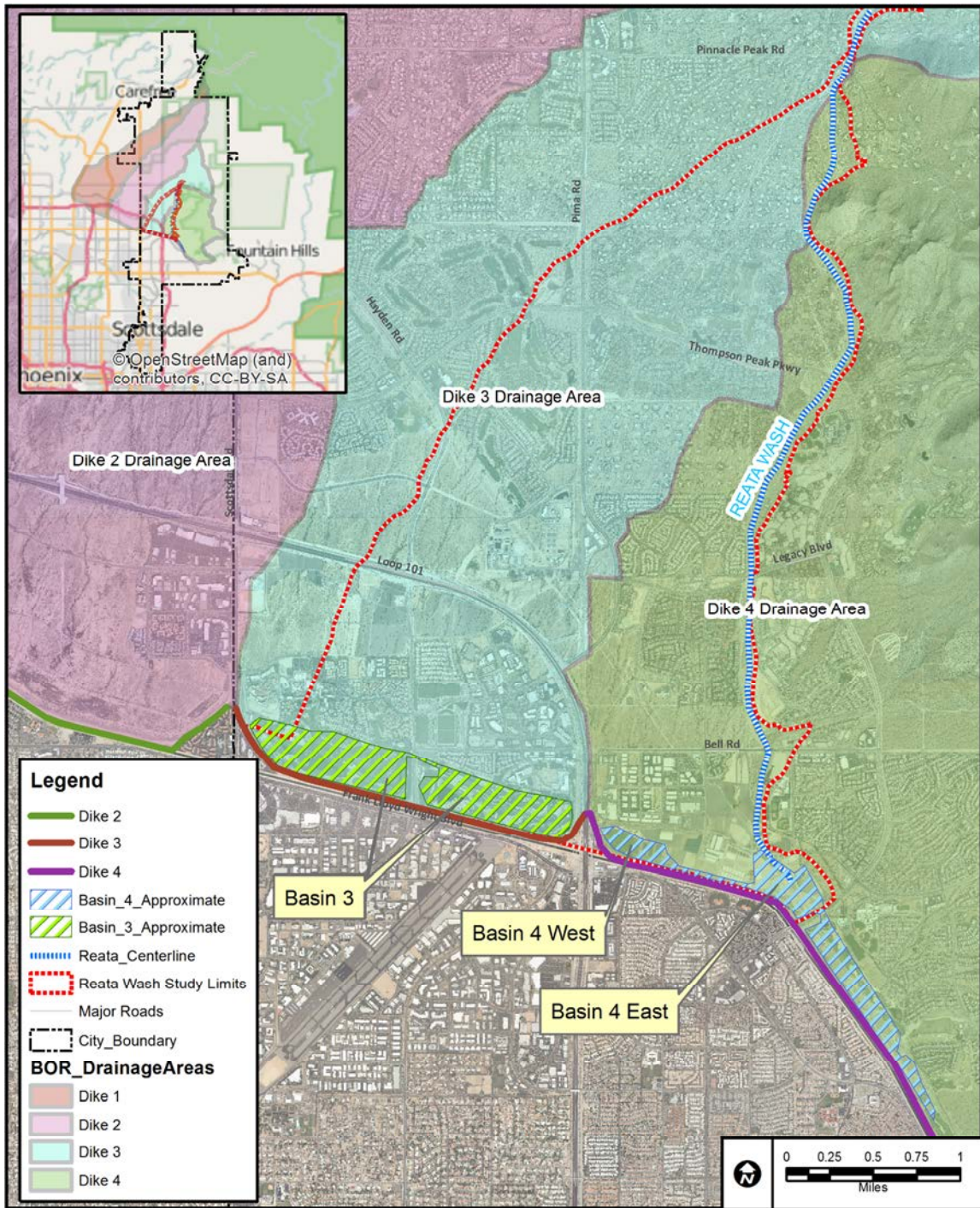

Figure 10.1 East and West Basins

The Memorandum: Central Arizona Project – Flood Volume Assessment (prepared by JE Fuller Hydrology & Geomorphology, Inc.) is found in Appendix I of Volume III of the DCR.

All appendices in Volume III are provided on a DVD.

11. SEDIMENT DOCUMENTATION REVIEW AND SEDIMENT YIELD

A review of existing sediment yield studies was conducted including recommendations regarding their applicability to the Reata Wash Study. Sediment yield is the volume of soil material and sediment transported from a watershed through its stream network. Sediment yield is an important design parameter for flood control structures because sediment deposition in dams, reservoirs, or floodways reduces the storage or transport capacity. Reduced capacity of flood control structures increases the likelihood of overtopping during flood events, increasing the probability of injuries, damage to downstream property and the structure itself.

Previous sediment yield estimates were identified during the data collection phase (see Volume III, Appendix J). These estimates are appropriate for concept-level Reata Wash Study evaluation. However, should the Reata Wash Study be approved by City Council for advancement, new sediment yield estimates should be developed.

Sediment yield could influence the design and function of the Reata Wash channel system due to the following:

- Capacity
- Performance
- Maintenance
- Regulatory issues

There are three primary sources of sediment yield for the Reata Wash Study. The first is from the upper watershed, as measured at the apex of the Reata Pass Alluvial Fan located near Pinnacle Peak Road as shown in Figure 11.1. This sediment load would consist of sands, gravels, and cobbles (the bed material load) as well as finer-grained sediments normally carried in suspension in flood waters (the suspended and wash load). The second source of sediment yield is from tributaries that enter the study area downstream of the alluvial fan apex. These include some small unnamed watersheds that drain the foothills of the McDowell Mountains near the apex, North and South Beardsley Washes which drain the western slopes of the McDowell Mountains, and the watersheds now captured by the Thompson Peak Channel (near Bell Road). Each of these tributaries deliver not only flood

water, but also volumes of sediment that must be accounted for in the Reata Wash Study. The sediment delivered from these tributaries is similar in composition to that of the sediment associated with the fan apex, although the volume would be different as a function of the watershed size, physiography, geology, and hydrology. The third source of sediment yield to the study area is from the many channels and upland surfaces within the Reata Pass Alluvial Fan landform. Flow along the alluvial channels of the Reata Pass Alluvial Fan has the capacity to erode the stream beds and banks. This sediment is then added to the load delivered to downstream reaches. The sediment sizes delivered from the channels within the Reata Wash Study would be a function of the channel design, but are most likely to include predominantly sand and gravel sized material (see Volume III, Appendix J).

It is recommended that FCDMC standards and methodologies be used as a guide for sedimentation and scour analyses for the Reata Wash Study. In addition, it is recommended that the Reata Wash corridor sediment transport modeling utilize hydrographs updated as part of the Reata Wash Study, historic sediment sample data, and applicable sediment inflow data.

The Memorandum: Sediment and Stable Channel Assessment: Review of Historical Documentation (prepared by JE Fuller Hydrology & Geomorphology, Inc.) is found in Appendix J of Volume III of the DCR.

The Memorandum: Sediment and Stable Channel Assessment: Sediment Yield (prepared by JE Fuller Hydrology & Geomorphology, Inc.) is found in Appendix K of Volume III of the DCR.

All appendices in Volume III are provided on a DVD.

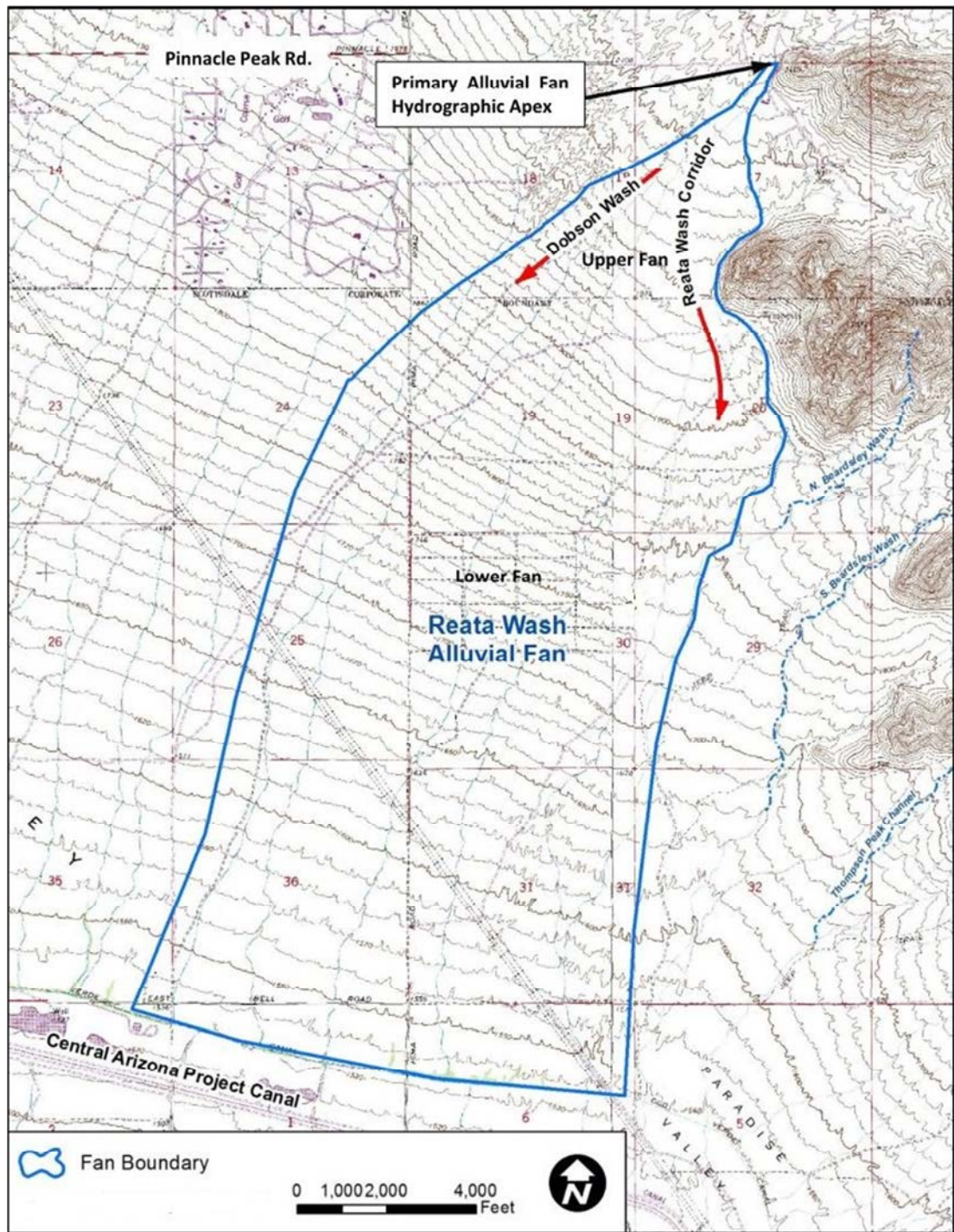

Figure 11.1 Reata Wash Alluvial Fan Landform & Boundaries

12. SEDIMENT AND STABLE CHANNEL ASSESSMENT, AND GEOMORPHIC ASSESSMENT

In existing conditions Reata Wash flows onto a moderately large alluvial fan landform located adjacent to the western slopes of the McDowell Mountains. Large portions of the fan landform were mapped as an active alluvial fan by FEMA. Although from more recent analyses it is believed that only portions of the fan landform are in fact active. Most of the landform is inactive, subject to sheet flooding and stable distributary flow (a flow in which the channels split downstream, creating more possible flow paths), or has stable tributary drainage paths on older inactive fan surfaces. The upper portion of the Reata Pass Alluvial Fan landform is the most active portion of the alluvial fan. Near its hydrographic apex, as shown in Figure 11.1, where the main channel loses the capacity to contain flooding and changes the channel pattern from tributary to distributary, is potentially subject to active alluvial fan flooding during large floods. However, during the 60-year period of record of aerial photographs, even this portion of the fan has been relatively inactive, primarily due to the lack of large flood events.

A geomorphic assessment of the Reata Wash Study area was conducted:

- To document existing channel conditions and likely flood and sedimentation conditions
- To better understand the geologic features and landforms within the watershed
- To understand the geomorphic processes taking place within the channel and overbank areas

The geomorphic assessment focused on the active portion of the fan landform near the hydrographic apex and the potential Reata Wash channelization corridor (see Volume III, Appendix L).

The watershed area above the primary hydrographic apex located at Pinnacle Peak Road is approximately eight square miles. The total watershed area more than doubles in size downstream of the primary hydrographic apex from runoff due to tributary watersheds draining the McDowell Mountains. In addition, runoff caused by precipitation falling directly on the Reata Pass fan landform and on adjacent piedmont (a landform composed of

sediment material eroded from mountains and deposited on the valley floor) areas to the west, contributes to the watershed size. Natural flow paths located to the west on the adjacent Rawhide Wash alluvial fan landform once intermingled with the channels on the Reata Pass Alluvial Fan landform, but are now mostly hydrologically disconnected due to the effects of urbanization.

The mountain watershed areas upstream of the fan landform have steep slopes, are mostly undeveloped, and are underlain by bedrock or very shallow granitic soils. The piedmont areas are more gently sloping and are underlain by highly permeable, deep, granitic soils, and are now mostly developed as residential and commercial sites, with several large golf courses.

The Reata Wash drainage corridor is a relatively well-defined ephemeral wash, with a braided or distributary channel system confined between more stable, topographically higher piedmont surfaces. The stream channels in the Dobson Wash corridor are much less defined, and are strongly distributary, and rapidly transition to urban sheet flooding conditions.

The Memorandum: Sediment and Stable Channel Assessment: Geomorphic Assessment (prepared by JE Fuller Hydrology & Geomorphology, Inc.) is found in Appendix L of Volume III of the DCR.

All appendices in Volume III are provided on a DVD.

13. SEDIMENT TRANSPORT AND LOCAL SCOUR ASSESSMENT

A sediment documentation review of available historical sediment transport modeling assumptions and methodology was conducted to support recommendations for sediment methodology (see Volume III, Appendix M). Scour depths were also estimated along the Reata Wash Corridor. The purposes of this assessment were to evaluate the potential for sediment degradation or erosion and to incorporate the results into the evaluation of the existing bank protection, grade controls and bridge structures along the corridor. The assessment includes:

- Preparation of a with-project sediment transport model assuming full implementation of a build alternative. The sediment transport analysis was performed utilizing a series of storm events. The intent of the analysis is to examine long-term trends of scour and deposition as well as to make an estimate of sediment delivery to the CAP Reach 11 Dike 4 West Basin assuming implementation of improvements
- Local scour and erosion was evaluated along the Reata Wash corridor at critical locations as determined by the study team (e.g. crossings, levees, grade control structures, channel inflow locations, etc.), assuming implementation of a build alternative. FCDMC standards and methodologies were used for sedimentation transport modeling and scour analysis

The recommendations for sediment modeling assume full flow within the Reata Wash drainage corridor. Based on a review of the documents listed, it was recommended that FCDMC standards and methodologies be used as a guide for sedimentation and scour analyses for the Reata Wash Study as shown in Table 13.1.

The Memorandum: Sediment and Stable Channel Assessment: Sediment Transport and Local Scour Assessment (prepared by JE Fuller Hydrology & Geomorphology, Inc.) is found in Appendix M of Volume III of the DCR.

All appendices in Volume III are provided on a DVD.

Title	Modeling Assumptions and Methods
<p>Greiner, Inc., Scottsdale Desert Greenbelt Phase One Design: Reata Pass Wash Supplemental Conditional Letter of Map Revision (CLOMR), June 1, 1996</p>	<p>Sediment Modeling Assumptions/Document Highlights:</p> <ul style="list-style-type: none"> • Local Sediment Sampling • Yang’s Streampower Method • 6-hour storm Input hydrographs • Accumulated 100-year storm event in a series • Additional study related to Yang Sediment Transport Relationship <p>Scour Calculations/Document Highlights:</p> <ul style="list-style-type: none"> • Safety factor of 1.5 for scour calculations to determine design scour elevations • Used thalweg as lowest channel bed elevation • Bend and anti-dune Trough (Bed form) per ADWR “Design of Fluvial Systems” • Contraction, abutment and pier scour per FHWA “Evaluating Scour at Bridges” • Low Flow incisement set at 1.5 feet within excavated channels per SLA, “Engineering Design of Fluvial Systems” • Apex confinement added 3 feet of scour to overall depth near apex

Title	Modeling Assumptions and Methods
<p>Simons, Li & Associates, Inc, City of Scottsdale Desert Greenbelt Project Multiple Volumes: Reata Pass/Beardsley Wash Channel Response Analysis with Ultimate Levee Encroachment, February 1997</p> <p>Volumes:</p> <p>Volumes I (2/97) Volume II (1/97) Volume III (8/97) Volume IV Part 1 (8/97) Volume IV Part 2 (8/97)</p>	<p>Sediment Modeling Assumptions/Document Highlights:</p> <ul style="list-style-type: none"> • Local Sediment Sampling • Prepared discretized hydrographs for 100-year and the 10-year flood events <p>Scour Calculations/Document Highlights:</p> <ul style="list-style-type: none"> • Low Flow incisement set at 3 feet • Bed-form scour (ADWR Eq 4.25) • Contraction scour at bridges and narrowing channel sections (Modified Laursen Equation 1960) • Bend Scour (ADWR Eq. 5.25) • General Scour estimated using a single event 10-year HEC2-SR model run • Long-term degradation was estimated considering changes in sediment supply. Worse case used a 50% reduction in upstream sediment supply for the 100-year flood event. • Total Scour depth determined by multiplying a Safety factor of 1.3 to scour calculations then adding the long term degradation.

Table 13.1 Sediment Modeling Assumption and Methods

14. LEVEES AND LEVEE-LIKE STRUCTURES

In order to evaluate potential levees along the study corridor, a levee identification and assessment task was conducted in support of the Reata Wash Study (see Volume III, Appendix N). It was determined that there are three locations where levees or levee like embankment structures occur. These areas are located along the west bank area of Reach 4, as shown on Figure 14.1:

- Bell Road potential levee (approximately 1,200 feet north of Bell Road)
- Reata Wash south flood protection (approximately 4,200 feet north of the Bell Road levee to Legacy Blvd.)
- Reata Wash north flood protection (approximately 4,300 feet north of Legacy Blvd., south of Deer Valley Road alignment)

A levee is considered accredited by FEMA if evidence has been presented showing that the structure meets current design, construction, maintenance, and operation standards to enable it to provide protection from the one-percent-annual-chance (100-year) flood. This evidence is typically documented in a report and submitted to FEMA with a certification statement by a licensed professional engineer. The levee owner (an agency) is responsible for ensuring that the levee is maintained and operated properly, and for providing evidence of certification. If it can be shown that a levee provides the appropriate level of protection, then FEMA would "accredit" (recognize). It is noted that while FEMA accredits levees that meet Title 44 Chapter 1, Section 65.10 of the Code of Federal Regulations (44CFR65.10) criteria, FEMA does not perform the actual certifications.

In summary, more action is needed to determine the status of potential levees being FEMA compliant or if the raised earthen embankment area is just an embankment and not required to meet FEMA levee requirements. The Bell Road levee is a levee structure, and requires more review to ensure it satisfies FEMA criteria, as it currently exists. There is an opportunity that the Bell Road levee needs additional fill material to satisfy FEMA freeboard requirements. The south and north flood protection (potential levees) could actually end up being a combination of levees or earthen embankments (not levees). Further study is required of the south and north potential levee to reach a determination.

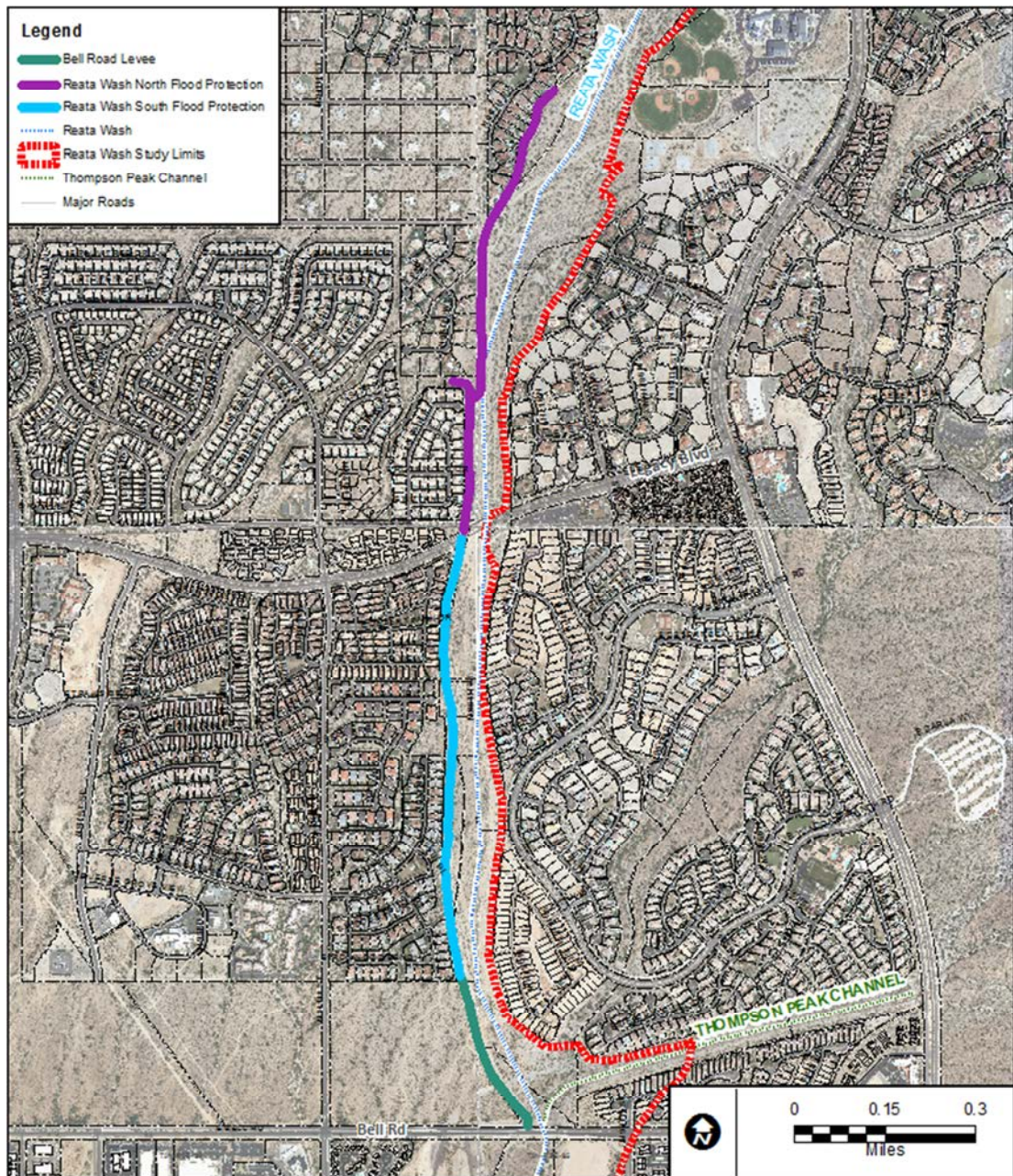

Figure 14.1 Reata Wash Potential Levees (Reach 4)

The Memorandum: Potential Levee Identification and Assessment (prepared by JE Fuller Hydrology & Geomorphology, Inc.) is found in Appendix N of Volume III of the DCR. All appendices in Volume III are provided on a DVD.

15. EXISTING DRAINAGE CORRIDOR

Hydraulic modeling of the existing Reata Wash drainage corridor occurred using the USACE's Hydraulic Engineering Center's River Analysis System computer program (see Volume III, Appendix O). The drainage corridor was divided into five distinct hydraulic reaches as shown on Figure 2.1 and in Volume II, Exhibit 1 – Study Location Reach Map. Existing condition hydraulic modeling was performed for all reaches except Reach 2. Reach 2 does not have an existing conveyance system to convey the 100-year base flood peak discharge (peak discharge). The peak discharge used in this analysis is based upon the results of the study's hydrology analysis, which identified a FEMA compliant 100 year peak discharge. Due to the steep terrain, the flow regime is supercritical for most of the study. The existing condition floodplain limits have been delineated based on critical depth, per FEMA criteria, which are deeper than supercritical flow depths and therefore result in a conservative floodplain limits. Potential deficiencies have been identified based on the existing condition within the corridor on a per reach basis as follows:

- Reach 1 - Pinnacle Peak Road to 1,000 feet north: The existing condition hydraulic model documents the existing wash or conveyance area does not have the capacity to contain the study's peak discharge. As a result, the existing condition floodplain extends well beyond the existing homeowner's drainage easement. The Pinnacle Peak Road Bridge has the capacity to convey the 100 year peak discharge but due to the non-containment flow the western portion of the foodplain continues south – southwest overland not flowing through the bridge.
- Reach 2 – Pinnacle Peak Road to Cross Canyon Way: The northern part of this reach reflects the active portion of the alluvial fan and the ability of floodwater to flow either to the south (Reata Wash) or to the southwest (Dobson Wash) or both directions. Reach 2 lacks an existing defined drainage channel of sufficient size to contain and convey the peak discharge within this reach.
- Reach 3 – Cross Canyon Way to Thompson Peak Parkway: Similar to Reach 2, the northern segment of this reach does not have the capacity to contain and convey the

- peak discharge within existing City land rights. Flow also appears to break out to the west along this reach. The middle and southern segments of the reach do have capacity and containment for the majority of the segments. The existing floodplain does encroach into several private properties along the western floodplain boundary.
- Reach 4 - Thompson Peak Parkway to Bell Road: The peak discharge is contained within property where the City has land rights along this entire reach with an exception along the east bank south of Thompson Peak Parkway where the floodplain encroaches slightly into DC Ranch Park and at Ironwood Village 8-C (whose plat displays a strip of land labeled flood hazard area). There are three locations within this reach where existing culverts convey low flows from Reata Wash to the southwest into washes that may meet the requirements of being designated as CWA Section 404 washes. Although the three culverts allow floodwaters to be diverted out of Reata Wash's study corridor no reductions in peak discharges have been applied to the Reata Wash study corridor downstream of these culverts.
 - Reach 5 – Bell Road to East McDowell Mountain Ranch Road: Downstream of the Bell Road Bridge, the peak discharge exceeds the conveyance capacity of the existing limited in size channel, and the floodplain spreads out over a large unconfined path well beyond the limits of the corridor owned by the City.

The existing condition floodplain is as shown on Volume II, Exhibit 2 – Study Location Reach Map and Existing Condition Floodplain.

The Memorandum: Existing Condition Hydraulic Capacity (prepared by Wood, Patel & Associates, Inc.) is found in Appendix O of Volume III of the DCR.

All appendices in Volume III are provided on a DVD.

16. PROPOSED DRAINAGE CORRIDOR

The recommended solution for the proposed hydraulic conditions of the Reata Wash drainage corridor was modeled using the USACE's Hydraulic Engineering Center's River Analysis System computer program (see Volume III, Appendix P). The drainage corridor was divided into five distinct hydraulic reaches as shown on Figure 2.1 and Volume II, Exhibit 1 – Study Location Reach Map. Proposed condition hydraulic modeling was performed for all five reaches as defined in Section 15.

The recommended solution addresses the potential technical deficiencies within the drainage corridor, minimizes the drainage system footprint and disturbance area, and takes into consideration the stakeholders, public, economic and aesthetic concerns. A summary of the analysis performed and the recommended options to support solutions are provided on a per reach basis as follows:

- Reach 1 – Pinnacle Peak Road to 1,000 feet north: This reach was analyzed with a 100-year peak discharge of 13,015 cfs. Three potential conveyance options were investigated for this reach:
 - An earthen trapezoidal channel
 - A concrete 'U' channel with grouted rock invert
 - A grouted rock trapezoidal channel

Rough surfaced hard lined open channel solutions are recommended within Reach 1 due to the anticipated high velocities, limited available drainage easement width and the need to collect overland side flows. Therefore, earthen trapezoidal channel option was eliminated from consideration and the options considered include a 'U' channel with grouted rock invert and a grouted rock trapezoidal channel.

The recommended solution includes a floodwall at the upstream end of this study reach to prevent an existing condition flow breakout, an incised concrete 'U' channel with a grouted rock invert, and a concrete channel transition to the existing bridge section. The

recommended solution cross sections are as shown on Figure 16.1 (Reach 1 Typical Sections).

The Pinnacle Peak Road Bridge has the hydraulic capacity to convey the 100-year peak discharge, but floodwaters breakout before arriving at the bridge. Thus the bridge inlet area would need to be altered in the final design to prevent the breakout occurring to allow the bridge to convey the 100-year peak discharge.

The benefits of this recommended solution include reduction of additional land acquisition requirements; requires reasonable maintenance, is easily inspected and is efficient at collecting side flows and conveying flows at an acceptable velocity. The recommended solution is considered only moderately context sensitive, is not favorable to wildlife movement and would require safety railing.

Improvements within this reach may require City acquisition of land rights for construct of improvements and maintenance within the existing drainage easement owned by the Pinnacle Peak Heights Homeowners Association. Additional land rights are needed to accommodate permanent improvements on Lots 7 and 9 of Pinnacle Peak Heights subdivision in order to accommodate the proposed floodwall.

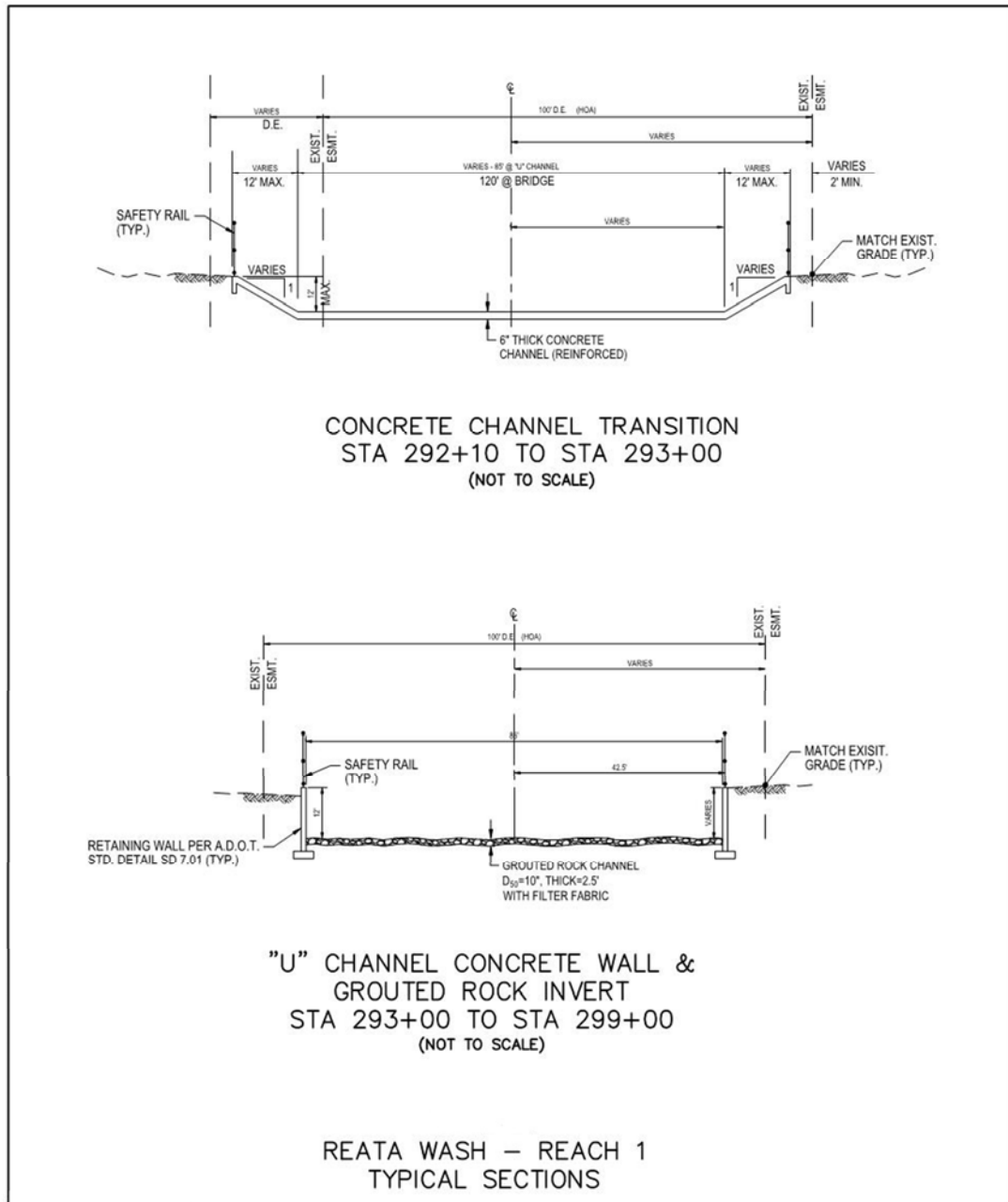

Figure 16.1 Reach 1 Typical Sections

- Reach 2 – Pinnacle Peak Road to Cross Canyon Way: This reach was analyzed with a 100-year peak discharge of 13,015 cfs from the Pinnacle Peak Road Bridge immediately downstream of Reach 1. There is a proposed flow release of 2,000 cfs to the southwest to provide flows to Dobson Wash. The 100-year peak discharge in Reata Wash is reduced to 11,015 cfs downstream of this release.

Five potential conveyance options were investigated for this reach including:

- An incised earthen trapezoidal channel
- A perched earthen trapezoidal channel with levee banks
- A concrete ‘U’ channel
- A grouted rock trapezoidal channel
- A covered concrete box culvert

The earthen channel options were considered less desirable due to the required land area being larger than other options, and thus were eliminated them from further consideration.

The recommended solution is a combined system consisting of a concrete ‘U’ channel from the Pinnacle Peak Road Bridge area to approximately 1,300 feet south and a grouted rock trapezoidal channel from that point downstream to Cross Canyon Way. Concrete box culverts with inlet and outlet headwalls would be required at Foothills Drive and Cross Canyon Way, and would be sized to convey the study’s 100-year discharge. The concrete ‘U’ channel would have a bottom width of 60 feet and a depth of approximately 13.5 feet with safety rails on top of the walls.

A rough undulating surface on both the walls and channel invert would be designed and constructed to emulate a rock surface which would increase the Manning’s “n” value and reducing flow velocities. A concrete channel transition structure is required immediately downstream of the Pinnacle Peak Road Bridge that would allow the flow to transition from the bridge outlet geometry to the concrete ‘U’ channel inlet geometry. At a point approximately 1,300 feet downstream of Pinnacle Peak Road Bridge, a divider wall is proposed within the channel to create a separation between the main flow in Reata Wash (11,015 cfs) and the Dobson Wash flow release (2,000 cfs). The final design would account

for this location to release the initial low flows into Dobson Wash, the concept as shown in Figure 16.2 (Dobson Wash Release).

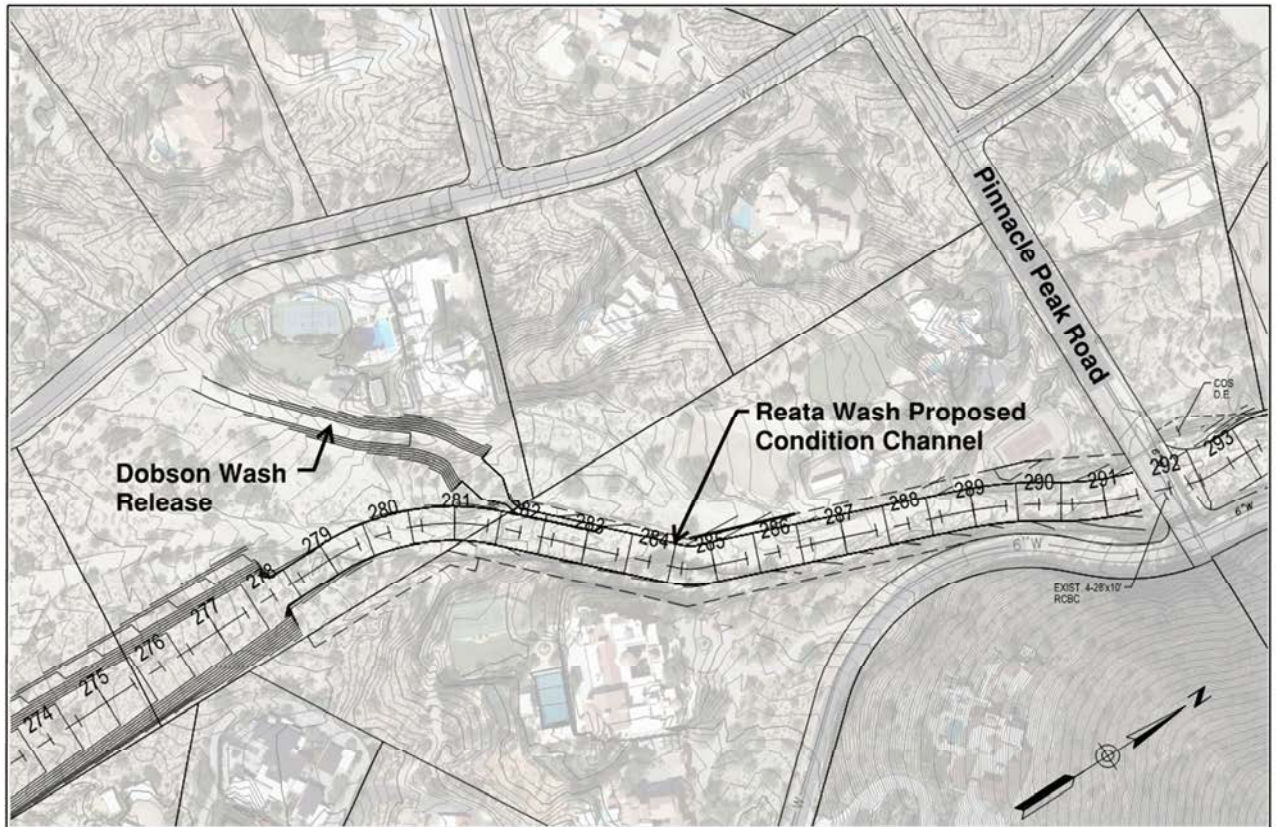

Figure 16.2 Dobson Wash Release (Reach 2)

Approximately 400 feet south of the Dobson Wash release, the conveyance system would transition from a concrete ‘U’ channel to an incised grouted rock trapezoidal channel with an 80 foot bottom width and 2:1 side slopes. There are several locations along this reach where offsite flows would need to be collected and conveyed into the proposed drainage system.

The benefits of the concrete ‘U’ channel segment of the recommended solution are that City land rights and existing drainage easement were utilized to minimize additional land acquisition. The recommended solution is anticipated to have reasonable maintenance costs and is easily inspected for maintenance requirements. This solution is also more efficient at collecting and conveying flows at an acceptable velocity and costs less than a covered concrete box culvert. The potential drawbacks of the concrete ‘U’ channel are that it is

considered moderately context sensitive, is not favorable to wildlife movement and would require safety railing.

The benefits of the grouted rock trapezoidal channel segment of the recommended solution are that it is moderately sensitive to land currently available for drainage improvements and has a moderate footprint to reduce additional land requirements. The recommended solution is anticipated to have reasonable maintenance costs and is easily inspected for maintenance requirements. This solution is also more efficient at collecting and conveying flows at an acceptable velocity and costs less than a covered concrete box culvert. The grouted rock trapezoidal channel has a larger footprint than the covered box culvert or the concrete ‘U’ channel. The recommended solution cross sections are as shown on Figure 16.3 (Reach 2 Typical Sections).

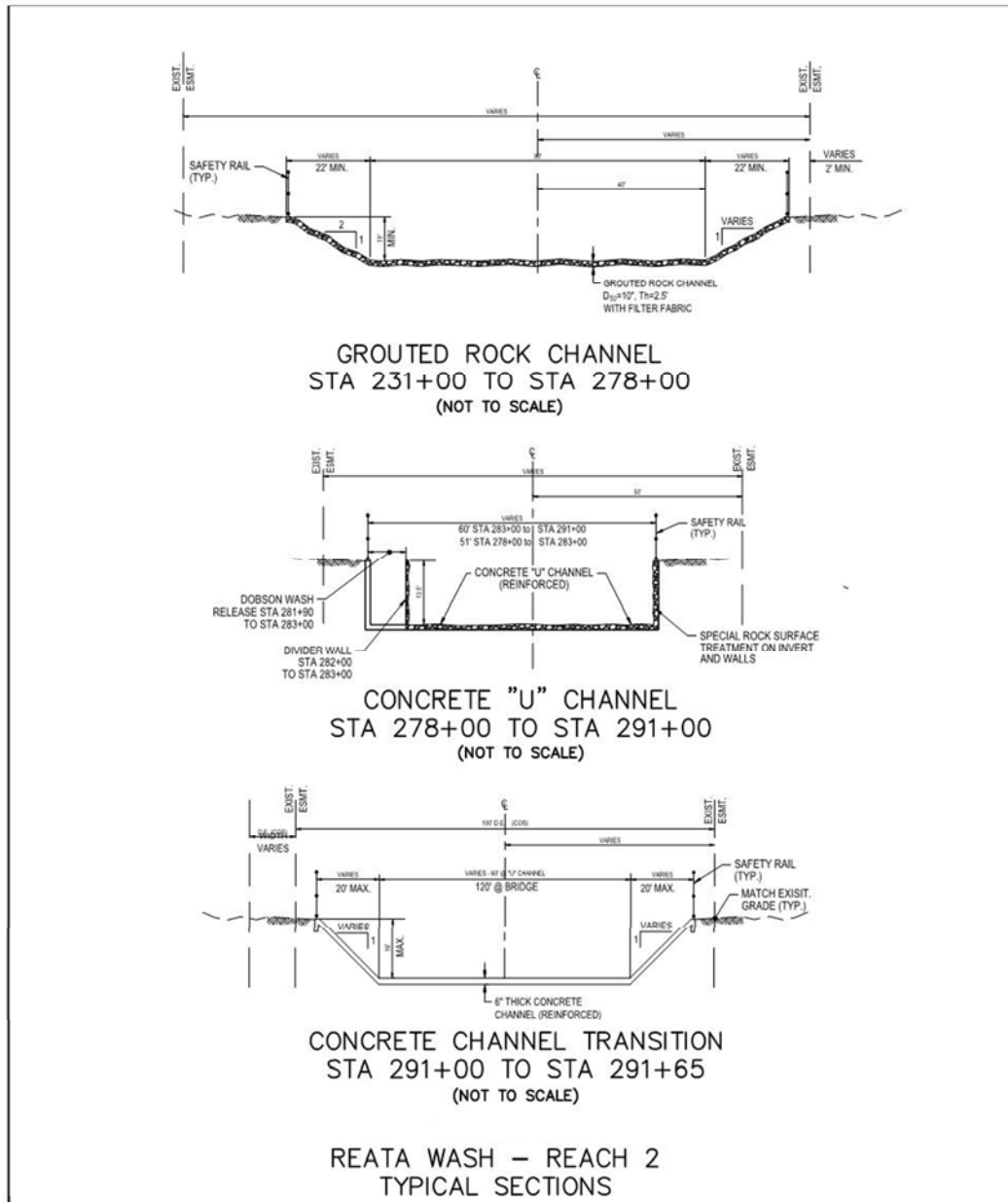

Figure 16.3 Reach 2 Typical Sections

• Reach 3 – Cross Canyon Way to Thompson Peak Parkway: This reach was analyzed with a 100-year peak discharge of 11,254 cfs at Cross Canyon Way and 11,901 cfs at Thompson Peak Parkway. The northern segment of this reach does not contain and convey the 100-year peak discharge within the property where the City has land rights. Flow breaks out both west and southwesterly along this segment and encroaches into several privately owned parcels near Cross Canyon Way. Three potential conveyance options were investigated for the northern segments of this reach including:

- A grouted rock trapezoidal channel
- A concrete ‘U’ channel
- A covered concrete box culvert

The recommended conveyance system in the northern segment of Reach 3 is an incised grouted rock trapezoidal channel with an 80 foot bottom width and 2:1 side slopes. In the southern segment of the reach, the existing condition floodplain does encroach into some residential lots along the west bank north of Thompson Peak Parkway. Buried and surface bank protection measures are recommended for this segment to address floodplain encroachments into private property. The proposed buried bank protection would be high enough to provide containment based on the proposed condition water surface elevation and deep enough to address the calculated potential scour depth. The recommended solution cross sections are as shown on Figure 16.4 (Reach 3 Typical Sections).

The existing buried bank protection along the east bank north of Thompson Peak Parkway may require improvements to achieve sufficient scour protection. The recommended solution for improving the buried bank protection is to construct a narrow width trench at the toe of the existing bank protection to a depth sufficient to meet the calculated potential scour depth and to fill the trench with pneumatically placed mortar.

The benefits of the recommended solution for this segment of the reach is that it can be constructed within the limits where the City has land rights, is considered context sensitive, favorable to wildlife, has a reasonable maintenance cost and costs less than the other two options considered.

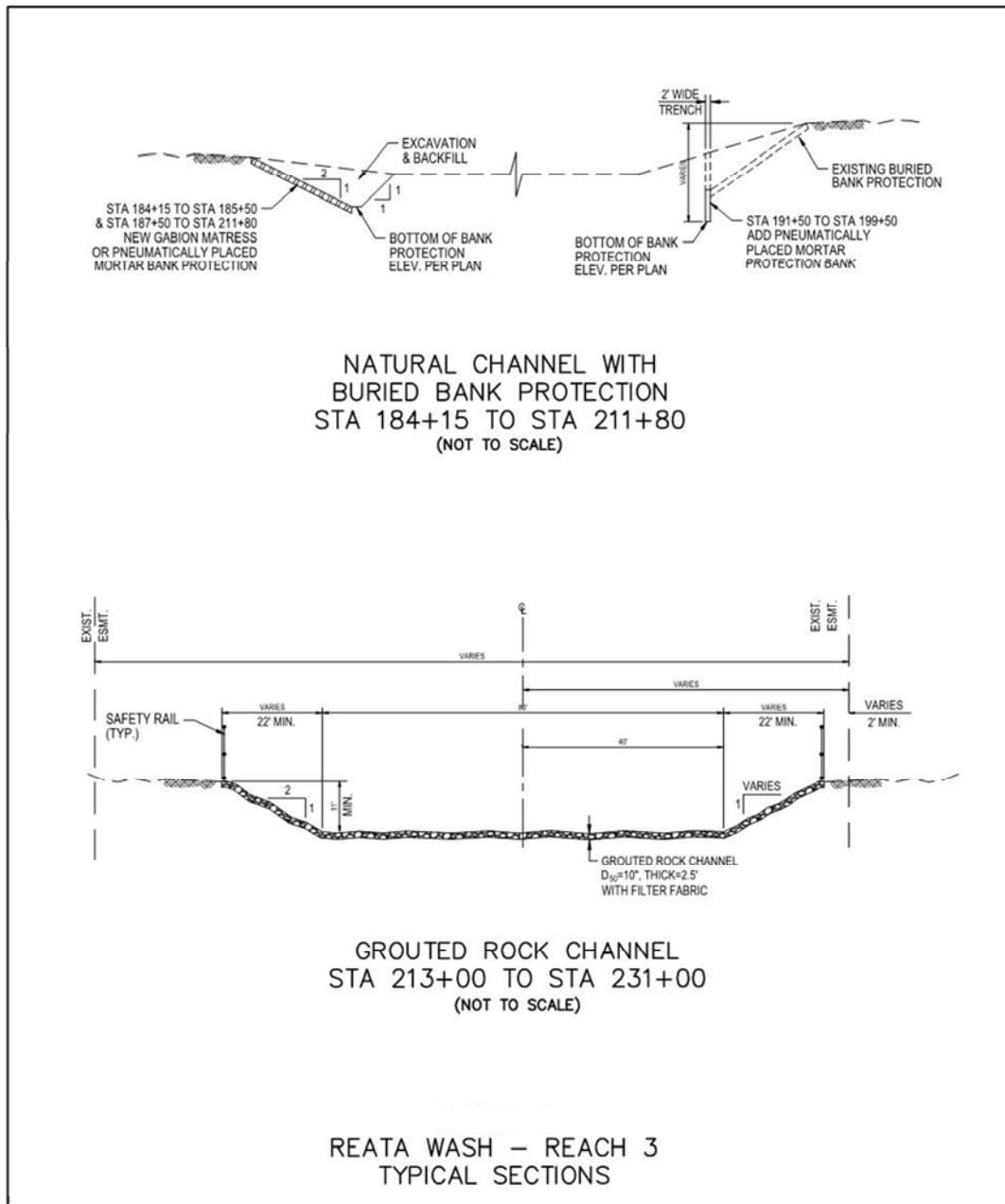

Figure 16.4 Reach 3 Typical Sections

- Reach 4 – Thompson Peak Parkway to Bell Road: This reach was analyzed with a peak flow of 11,901 cfs at Thompson Peak Parkway, 12,338 cfs at the confluence with North Beardsley Wash, 11,870 cfs at Legacy Boulevard and 15,842 cfs at the confluence with South Beardsley Wash and Thompson Peak Wash immediately upstream of Bell Road. The peak discharge is contained within City land rights along this entire reach with the exception of a narrow encroachment along the DC Ranch Park on the east side of Reata Wash south of Thompson Peak Parkway. Development has occurred along a majority of this reach which includes existing drainage control infrastructure (buried bank protection, grade control structures and embankments). Improvements to the existing buried bank protection may be required to achieve sufficient scour protection.

The recommended approach for addressing deficiencies the existing buried bank protection due to insufficient depth is to construct a narrow width trench at the toe of the existing bank protection to a depth sufficient to meet the calculated potential scour depth and install pneumatically placed mortar.

It was determined that there are three locations where levees or levee like embankment structures occur. These areas are located along the west bank area of Reach 4, More investigation is required for these areas. The Bell Road levee may be FEMA complaint with more earth fill to address a freeboard deficient. Increased bank heights and localized channel grading are recommended improvements at the other locations to meet potential levee or embankment requirements. The cross sections for the recommended buried bank protection and levee/embankment improvements are as shown on Figure 16.5 (Reach 4 Typical Sections).

There are three locations within this reach where existing culverts convey low flows from Reata Wash to the southwest; however, no reduction in peak discharges have been applied to the Reata Wash study corridor downstream of these culverts. The 100-year peak discharge is contained within City land rights along this entire reach. The benefits of the recommended solution for this reach are that it can be constructed within the limits where the City has land rights, it is considered context sensitive, favorable to wildlife and has a reasonable maintenance cost.

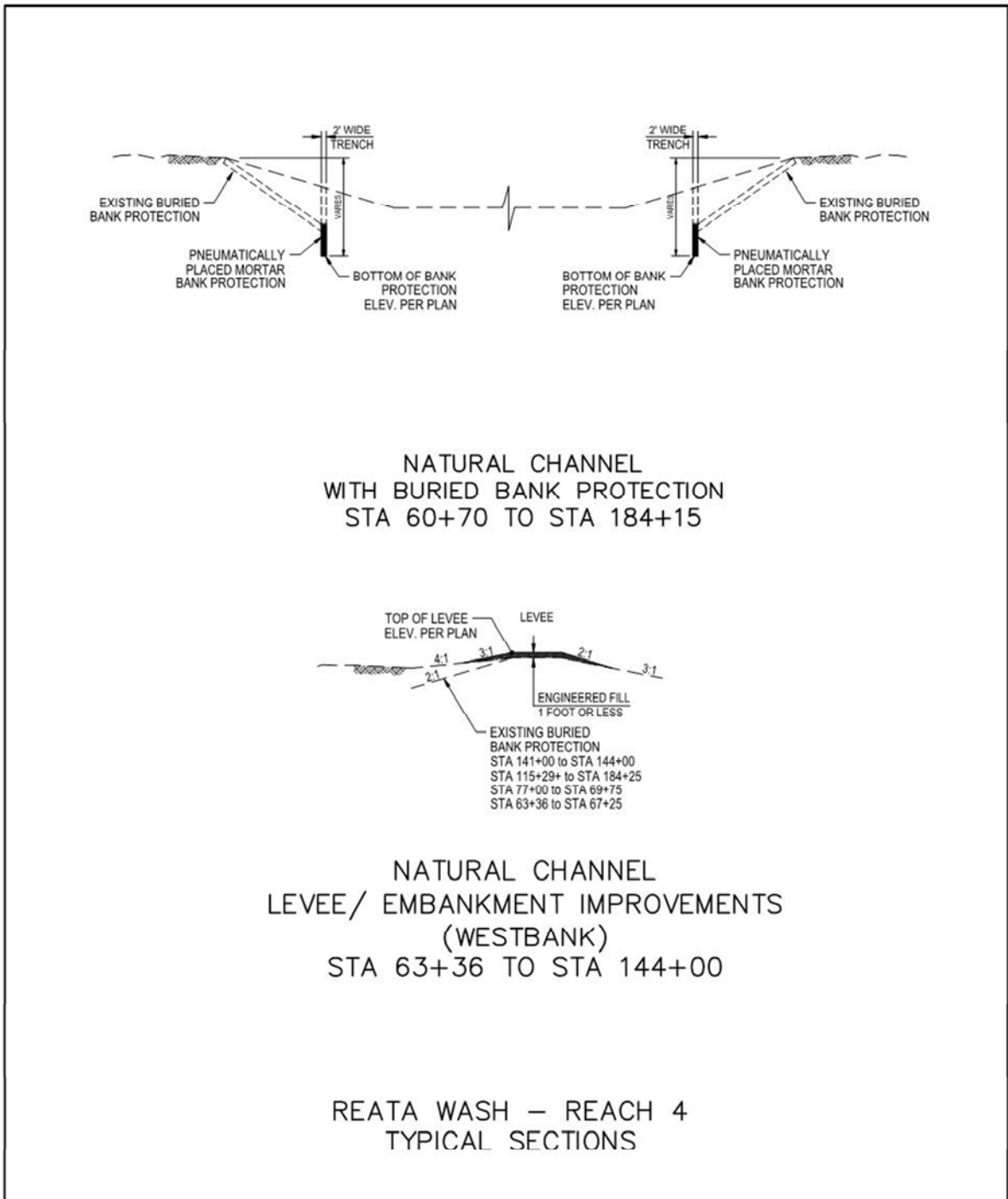

Figure 16.5 Reach 4 Typical Sections

- Reach 5 – Bell Road to East McDowell Mountain Ranch Road: This reach was analyzed with a peak flow of 15,842 cfs. Downstream of the Bell Road Bridge, the peak discharge exceeds the conveyance capacity of the existing limited in size channel and the floodplain spreads out over a large unconfined path well beyond the limits where the City has existing land rights.

Three potential conveyance options were investigated for this reach including:

- A concrete trapezoidal channel
- A grouted rock trapezoidal channel
- An incised earthen trapezoidal channel with buried bank protection

An incised earthen channel section was identified as the most desired option based on its context sensitivity and cost effectiveness.

The recommended solution to contain and convey the 100-year peak discharge within this reach is an incised earthen trapezoidal channel with buried bank protection, a 200-foot bottom width and 3:1 side slopes from the Bell Road Bridge to the McDowell Mountain Ranch Road Bridge.

A concrete drop structure is proposed as part of the recommended solution approximately 900 feet north of the McDowell Mountain Ranch Road Bridge. Immediately upstream of the McDowell Mountain Ranch Road Bridge, a 4 feet high concrete wall would be proposed in order to provide a sediment basin with approximately 9.1 acre-feet of storage capacity. The proposed improvements would require the relocation of an existing 8 inch non-potable waterline and 24 inch sanitary sewer line to immediately upstream of the proposed drop structure.

The benefits of the recommended solution are that it is anticipated to have reasonable maintenance costs and is easily inspected per maintenance requirements. This solution also costs less than a concrete or grouted rock trapezoidal channel and is considered context

sensitive and favorable to wildlife. The recommended solution cross section is as shown in Figure 16.6 (Reach 5 Typical Sections).

The proposed condition floodplain is as shown in Volume II, Exhibit 3 – Study Location Reach Map and Proposed Condition Floodplain.

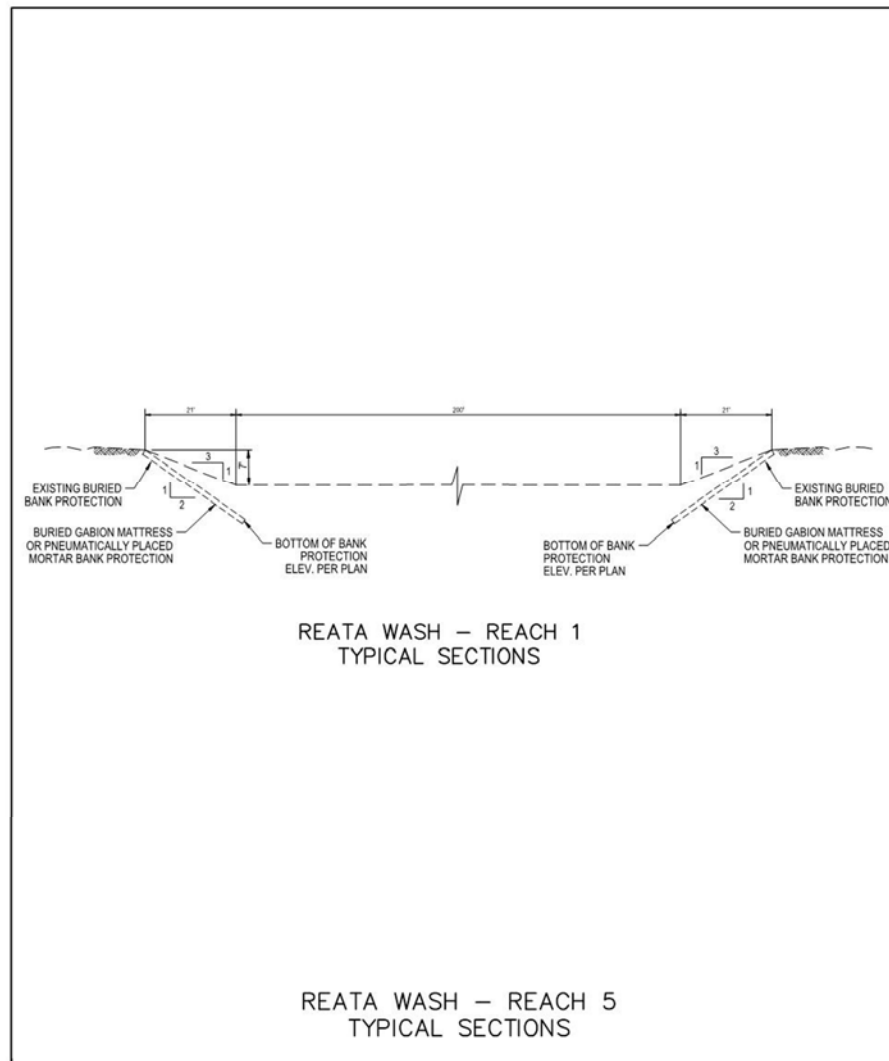

Figure 16.6 Reach 5 Typical Sections

The Memorandum: Proposed Condition Hydraulic Capacity (prepared by Wood, Patel & Associates, Inc.) is found in Appendix P of Volume III of the DCR.

All appendices in Volume III are provided on a DVD.

17. RECOMMENDED AND ALTERNATIVE SOLUTIONS

Three alternatives were investigated for recommendation as the potential solution. The three alternatives each share options for improving specific drainage corridor sections of the five reaches. Reach 3 and Reach 4 benefit from an existing built drainage corridor, totaling approximately 3 miles, of the Reata Wash's proposed 5.3 miles total length.

The recommended solution consists of a designated drainage conveyance corridor starting 1,000 feet north of Pinnacle Peak Road Bridge and continues south to the CAP, for a total of 5.3 miles. Using the recommended solution as a baseline, Alternatives B and C are compared to the recommended solution as follows:

17.1 Recommended Solution:

- Reach 1 – Pinnacle Peak Road to 1,000 feet north: In order to collect and convey the design peak discharge to the existing Pinnacle Peak Road Bridge, proposed improvements include channelization from the bridge to approximately 1,000 feet upstream. A hard lined “U” shaped channel with grouted rock bottom is proposed within this reach, along with a floodwall. The floodwall would prevent flow from breaking out to the southwest and would allow the peak discharge to be effectively collected and directed into the proposed downstream channel located within the existing drainage easement.
- Reach 2 North Segment – Pinnacle Peak Road to Dobson Wash and then to Station 278+00: A concrete “U” Shaped Channel is proposed downstream of Pinnacle Peak Road Bridge to approximately 1,350 feet south. A concrete channel transition structure is required immediately downstream of the Pinnacle Peak Road Bridge which would allow the flow to transition from the bridge outlet to the “U” shaped channel. A diversion wall is introduced at station 283+00 to direct initial flow and a portion of the peak flow from the Reata Wash corridor to flow into Dobson Wash up to a discharge split flow rate of 2,000 (cfs). At the Dobson Wash outlet, a transition outlet structure is proposed to dissipate energy from fast moving storm flow. In addition, at the end of the

outlet structure, a grader channel is proposed to facilitate a positive slope for the Dobson Wash outflow.

- Reach 2 Middle Segment – Station 278+00 to Foothills Drive Station 260+00: This reach proposes a grouted rock trapezoidal channel from Station 278+00 to Foothills Drive. A culvert crossing is proposed at Foothills.
- Reach 2 South Segment – Station 260+00 to Station 233+70 and Reach 3 North Segment Station 233+70 to Station 209+00: Within this reach, a grouted rock trapezoidal channel is proposed from Station 260+00 to Station 209+00. A culvert crossing is proposed at Cross Canyon Way.
- Reach 3 South Segment – South of Cross Canyon Way (Station 230+00) to Thompson Peak Parkway: New buried and surface bank protection measures are recommended for this segment along the west bank where they do not exist. The new protection would serve to contain the floodplain and eliminate floodplain encroachments into private property. In addition, additional improvements at the toe of the existing buried bank protection along some portions of the east bank may be required to address anticipated scour depths.
- Reach 4 – Thompson Peak Parkway to Bell Road: Drainage improvements, consisting of levees, embankments, and buried bank protection, have been constructed along a majority of this reach. There are some locations where these improvements may require enhancements to meet anticipated FEMA freeboard and scour requirements. In addition, new buried bank protection is proposed along both the east and west banks immediately south of Thompson Peak Parkway.
- Reach 5 – Bell Road to the CAP: This reach does not have the existing conveyance capacity to contain the design peak discharge. An incised earthen channel corridor with buried bank protection is proposed from Bell Road to the McDowell Mountain Ranch Road Bridge. A drop structure is proposed to allow channel flow to be discharged into a sediment basin. The sediment basin is required to collect sediment from the entire

channel conveyance system. Both public water and wastewater lines would require relocation.

17.2 Alternative B:

The Alternative B consists of most options used in the recommended solution, but the use of a box culvert option in lieu of the U channel option would be implemented, as follows:

- Reach 1 – Pinnacle Peak Road to 1,000 feet north: Reach 1 uses the same option as identified for the recommended solution.

- Reach 2 North Segment – Pinnacle Peak Road to Dobson Wash and then to Station 278+00: Alternative B incorporates a reinforced covered box culvert starting just downstream of Pinnacle Peak Road Bridge to approximately 1,350 feet south. A concrete channel transition structure is required immediately downstream of the Pinnacle Peak Road Bridge which would allow the flow to transition from the bridge outlet to the box culvert inlet. Initial low flows would be directed within this transition into the westernmost culvert barrel (dedicated for Dobson Wash flow) of a multi-barrel box culvert. This culvert barrel would allow a portion of the flow from the Reata Wash corridor into Dobson Wash up to the peak discharge split flow rate of 2,000 cfs. At the Dobson Wash outlet, a transition outlet structure is proposed to dissipate energy from fast moving storm flow. In addition, at the end of the outlet structure, a channel would be proposed to facilitate a positive slope for the Dobson Wash outflow.

- Reach 2 Middle Segment – Station 278+00 to Foothills Drive Station 260+00: Reach 2 Middle Segment uses the same option as identified for the recommended solution.

- Reach 2 South Segment – Station 260+00 to Station 233+70 and Reach 3 North Segment Station 233+70 to Station 209+00: Reach 2 South Segment uses the same option as identified for the recommended solution.

- Reach 3 South Segment – South of Cross Canyon Way (Station 230+00) to Thompson Peak Parkway: Reach 3 South Segment uses the same option as identified for the recommended solution.
- Reach 4 – Thompson Peak Parkway to Bell Road: Reach 4 uses the same option as identified for the recommended solution.
- Reach 5 – Bell Road to McDowell Mountain Ranch Road: Reach 5 uses the same option as identified for the recommended solution.

17.3 Alternative C:

The Alternative C consists of most options used in the recommended solution but the use of a box culvert option in lieu of the U channel and grouted rock channel would be implemented, as follows:

- Reach 1 – Pinnacle Peak Road to 1,000 feet north: Reach 1 uses the same option as identified for the recommended solution.
- Reach 2 North Segment – Pinnacle Peak Road to Dobson Wash and then to Station 278+00: Reach 2 North Segment uses the same option as identified for Alternative B.
- Reach 2 Middle and South Segment – Station 278+00 to Station 230+70 and Reach 3 North Segment Station 233+70 to Station 209+00: This reach incorporates a reinforced covered box culvert from Station 278+00 to Station 213+00. A concrete outlet structure is proposed because of the high velocities needing to transition to the natural channel corridor at Station 209+00.
- Reach 3 South Segment – South of Cross Canyon Way (Station 209+00) to Thompson Peak Parkway: Reach 3 South Segment uses the same option as identified for the recommended solution.

- Reach 4 – Thompson Peak Parkway to Bell Road: Reach 4 uses the same option as identified for the recommended solution.

- Reach 5 – Bell Road to McDowell Mountain Ranch Road: Reach 5 uses the same option as identified for the recommended solution.

18. RIGHT OF WAY

A right of way analysis was performed for the Reata Wash Study (see Volume III, Appendix Q). The analysis was based on the recommended solution for improvements based on a Concept Design Plan as (see Volume II, Exhibit 5) prepared at a 15% level of design for the Reata Wash Study. For the Reata Wash Study Corridor, 292 acres are required, of which the City is believed to have land rights to 279 acres (95.5%) of the land area required. To complete the corridor, the city would need land rights for 13 acres (4.5%) from nine property owners. Temporary construction and temporary access easements may also be required to support a potential project. These two areas where land rights require further clarification include Pinnacle Peak Heights (whose plat displays a drainage easement north of Pinnacle Peak Road Bridge) and at Ironwood Village 8-C (whose plat displays a strip of land labeled flood hazard area). The Maricopa County Recorder's website was used to identify the property owner's names and addresses, assessor parcel numbers, and to support development of exhibits.

The proposed Reata Wash Study drainage corridor alignment and land rights are as shown in Volume II, Exhibit 4 - Land Rights.

The Memorandum: Right-of-Way (prepared by Wood, Patel & Associates, Inc.) is found in Appendix Q of Volume III of the DCR.

All appendices in Volume III are provided on a DVD.

19. CONSTRUCTION COST AND QUANTITIES

Quantities were estimated for providing an Opinion of Probable Construction Cost (construction cost) based on the Concept Design Plan (see Volume II, Exhibit 5) prepared at a 15% level of design for the Reata Wash Study. The construction cost for the recommended solution is based on the estimated quantities.

The Reata Wash Study developed three alternatives using various flood control options. All options meet technical requirements identified for the Reata Wash Study. One alternative was selected and is referred to as the recommended solution. The construction costs for the recommended solution and the two alternatives are summarized below. It is noted that the costs for the City to acquire land rights are not included in construction cost, but are included in the Benefit Cost Analysis.

The construction cost for of the recommended solution is estimated to be \$43,000,000 as shown in Table 19.1. Alternative B construction cost is \$46,500,000 and Alternative C construction cost is \$68,000,000.

Reata Wash Flood Control Improvement Study

Recommended Solution

The Reata Wash Flood Control Improvement Study recommends an alignment which is 27,800 feet in length. Various channel section improvements were selected as recommended options for satisfying technical drainage conveyance criteria.

The Recommended Solution includes the following:

Reach 1 - 'U' Channel with concrete retaining walls and Grouted Rock invert from Station 300+00 to Pinnacle Peak Road

Reach 2 - Concrete 'U' Channel from Pinnacle Peak Road to Station 278+00 and Grouted Rock Channel from Station 278+00 to Reach 3

Reach 3 - Grouted Rock Channel from Reach 2 to Station 209+00, Bank Protection Enhancements from Station 209+00 to Thompson Peak Parkway

Reach 4 - Levee and Bank Protection Enhancements from Thompson Peak Parkway to Bell Road

Reach 5 - Earthen Trapezoidal Channel from Thompson Peak Parkway to McDowell Mountain Ranch Road

Preliminary Opinion of Probable Construction Cost (15% Design Level)

<u>Study Reach</u>	<u>Amount</u>
Reach 1	\$2,319,627
Reach 2 North Segment	\$6,251,201
Reach 2 Middle Segment	\$5,393,183
Reach 2 South & Reach 3 North Segments	\$13,826,003
Reach 3 South Segment	\$2,103,788
Reach 4	\$3,264,249
Reach 5	\$9,823,685
<u>Grand Total</u>	\$42,981,734

Land Right Acquisition costs not included

Table 19.1 Recommend Solution

The Memorandum: Construction Cost and Quantities (prepared by Wood, Patel & Associates, Inc.) is found in Appendix R of Volume III of the DCR.

All appendices in Volume III are provided on a DVD.

20. BENEFIT COST ANALYSIS

The Reata Wash Study utilized a benefit cost analysis to evaluate economic advantages (benefits) and disadvantages (costs) of a potential project. The end result is a benefit cost ratio, which is derived from a project's total net benefits annualized divided by its total project cost annualized. The benefit cost ratio is a numerical expression of the cost effectiveness of a project. A project is considered to be cost-effective when the benefit cost ratio is 1.0 or greater indicating the benefits of a potential hazard mitigation project are greater than the cost to complete the project. Additional background and information for evaluating cost effectiveness of potential flood mitigation projects is found at FEMA website <http://www.fema.gov/benefit-cost-analysis>.

The benefit cost ratio for the Reata Wash Study was calculated using the estimated cost of construction, the CWA Section 404 Permit mitigation cost, land acquisition cost and maintenance cost of the recommended solution based on a 15% level design plan. The annualized estimated construction cost, the CWA Section 404 Permit mitigation cost and land acquisition cost were added together with the annual cost for maintenance, and then divided by the annualized costs associated with benefits of removing structures and content from flood hazards as shown in Table 20.1.

Based on the annualized benefit of \$3,702,818 and annualized cost of \$1,779,354 the benefit cost ratio was determined to be 2.08. This indicates the benefits of a potential flood hazard mitigation project are sufficient to justify consideration for a project.

The following items were identified as being specific to the Reata Wash Study for matters that benefit and cost, as follows:

Matters That Benefit:

- Removal of majority of 4,600 structures from flood hazards
- Removal of mandatory flood insurance requirements for structures
- Removal of approximately 5,200 acres from flood hazards
- Removal of roadways/intersections from flood hazards (reduces the chance of disruption)
- Removal of wet and dry utility lines from flood hazards (reduces the chance of disruption)
- Removal of flood hazards increases the chance emergency vehicles, first responders are able to reach those in need
- Reduction in public maintenance costs associated with clean up
- Removal of flood hazards allows economic commerce to continue
- Removal of flood hazards diminishes risk of injury and loss of life, in a flood event

Matters That Cost:

- Construction cost
- Maintenance cost
- Permitting
- Land rights

The benefit cost analysis results documented that the recommended solution has a benefit cost ratio greater than 1.0 indicating the benefits of a potential flood hazard mitigation project are sufficient to justify consideration for a project, with respect to cost-effectiveness and flood hazard prevention. Based on the annualized benefit of \$3,702,818 and annualized cost of \$1,779,354 the benefit cost ratio was determined to be 2.08.

Benefit Cost Ratio 100-year Flood	
Category	Recommended Solution
Construction Cost	\$43,000,000
Annualized Construction Cost (a)	\$1,408,675
Annual OMRR&R Cost (b)	\$200,000
Annualized CWA Section 404 mitigation Cost (a,c)	\$56,019
Annualized Land Acquisition Cost (a,d)	\$114,660
Total Annual Cost	\$1,779,354
Annual Benefits (a,e)	\$3,702,818
Net Benefits	\$1,923,464
Benefit Cost Ratio	2.08
<u>EXPLANATIONS</u>	
(a): 2016, Annualized Costs Based on 3.125 % over 100-year Time Span	
(b): Operation, Maintenance, Remediation, Rehabilitation and Repair	
(c): Annualized CWA Section 404 Mitigation Cost (based on \$1,710,000)	
(d): Annualized Land Acquisition Cost (based on 13 acres at \$250,000 per acre and \$250,000 allowance for Drainage Easements: \$3,500,000)	
(e): Flood Damage based on FEMA data and Draft Pinnacle Peak Area Drainage Master Study	

Table 20.1 Benefit Cost Ratio

The prevention or avoidance of flood damage cost is a benefit. The flood damage cost was estimated based on the data available from FEMA's website (Reference 2, found at the end of this section). The website provides estimated flood damage for a 1,000 and 2,000 square foot home and variable flood depths (.083 feet to 4 feet) above floor elevations. Since most of the FEMA floodplain area homes in the Reata Wash floodplain have with larger foot prints, the cost of damage was adjusted based on 3,500 square foot home as shown in Table 20.2. Flood depths less than 0.5 feet are displayed within Table 20.2, but the Reata Wash Study did not account for damage until 0.5 feet was reached.

Cost of Flood Damage			
Flood depth vs Damage Based on One Occurrence			
Source: FEMA (a)			
Flood depth (ft) Above Floor	1,000 SQ. FT. Home	2,000 SQ. FT. Home	3,500 SQ. FT. Home (b)
0.083	\$10,600.00	\$20,920.00	\$36,610.00
0.166	\$10,670.00	\$21,000.00	\$36,750.00
0.333	\$15,150.00	\$29,650.00	\$51,887.50
0.5	\$20,150.00	\$39,150.00	\$68,512.50
1	\$27,150.00	\$52,220.00	\$91,385.00
1.5	\$30,425.00	\$57,550.00	\$100,712.50
2	\$33,700.00	\$62,880.00	\$110,040.00
2.5	\$35,150.00	\$65,490.00	\$114,607.50
3	\$36,600.00	\$68,100.00	\$119,175.00
3.5	\$38,275.00	\$71,340.00	\$124,845.00
4	\$39,950.00	\$74,580.00	\$130,515.00
<u>Explanations</u>			
(a): https://www.floodsmart.gov/floodsmart/pages/flooding_flood_risks/the_cost_of_flooding.jsp			
(b): Values extrapolated from 1,000 SQ FT and 2,000 SQ FT Home columns			

Table 20.2 Cost of Flood Damage

The number of structures impacted and respective flooding depths above floor for the 100-year storm event is summarized as shown in Table 20.3. The number of structures impacted and their respective flood depths were interpreted from City of Scottsdale Draft Pinnacle Peak South Area Drainage Master Study.

Damage Estimate for a 3,500 SQ. FT. Home			
Flood Depth vs Structure Damage: 100-Year Flood			
Flood Depth Above Floor (ft.)	Number of Structures Impacted	Structure Damage	Total Damage
0.51-1	611	\$91,385	\$55,836,235
1.01-1.5	307	\$100,713	\$30,918,738
1.51-2	125	\$110,040	\$13,755,000
2.01-2.5	72	\$114,608	\$8,251,740
2.51-3	22	\$119,175	\$2,621,850
3.01-3.5	9	\$124,845	\$1,123,605
3.51-4	4	\$130,515	\$522,060
TOTAL	1150		\$113,029,228

Table 20.3 Damage Estimate for a 3500 SQ. FT. Home

It is important to note that the Benefit Cost Ratio is based upon damages from the 100 year flood event occurring along one flow path within the 5,200 acre FEMA floodplain. The 100 year flood event was modeled using the western portion of the alluvial fan FEMA floodplain, commonly referred to as the Dobson Wash area. The analysis uses the hydraulic modeling developed for the City of Scottsdale’s Draft Pinnacle Peak South Area Drainage Master Study. The FEMA designated floodplain contains approximately 4,600 structures. The 100 year flood event was estimated to damage 1,150 homes within the floodplain, accounting for flood depth equal to or greater than 0.5 feet.

The discount rate formula established in the Water Resources Development Act of 1974 was used to develop annualized costs. This formula bases the discount rate on the average yield of long-term government securities. The USACE uses a process known as “discounting” to convert future benefits and costs to present values. Discounting requires use of an interest rate known as the discount rate as shown in Table 20.4.

Annualized Cost Analysis for Various Study Elements				
Study Element	Construction Cost Analysis	CWA Section 404 Mitigation Cost	Land Acquisition Cost Analysis	Removal of Flood Damages to Structure Analysis
Annual Interest Rate	3.125%	3.125%	3.125%	3.125%
Time Span in years	100	100	100	100
Number of Payments Per Year	1	1	1	1
Amount to be Analyzed	\$43,000,000	\$1,710,000	\$3,500,000	\$113,029,000
Number of Annual payments	1	1	1	1
Annual Interest Payment	\$1,343,750	\$53,438	\$109,375	\$3,532,156
Annual Principal Payment	\$64,925	\$2,582	\$5,285	\$170,662
Annual Payment	\$1,408,675	\$56,019	\$114,660	\$3,702,818

Table 20.4 Annualized Cost Analysis for Various Study Elements

The following were not accounted for in the benefit cost analysis. If these matters were to be included in the benefit cost analysis, it would result in a more beneficial analytical result to support a future project:

- 1) FEMA flood damage tables start applying damage costs at 0.1 foot of flood depth above floor. Damages are likely to occur at depths under 0.5 foot but the Reata Wash Study did not account for damage until 0.5 foot depth was reached.
- 2) A single 100 year flood event was used to estimate FEMA flood damages. It should be noted that more frequent flood events would statistically occur over a 100 year time period. These more frequent flood events would cause additional damage that is not accounted for in the benefit cost analysis. If additional (more frequent) events are accounted for within the 100 year period, the benefit cost ratio number would increase.

- 3) The owners of the structures in the study area pay an approximate annual burden of \$1.8 million in FEMA flood insurance policy premiums (year 2016). Flood insurance costs were not included or accounted for in the benefit cost analysis.
- 4) FEMA's flood damage tables only account for potential flood damage to homes. However, additional damages are likely to occur in the study area. Anticipated damages to both public and private infrastructure could include:
 - Water lines
 - Wastewater lines
 - Roadways and intersections
 - Culverts and drainage infrastructure
 - Utility owned electric, natural gas and cable lines
 - Privately owned yards, walls and driveways

While damages to these facilities are likely to occur in a significant flood event, the associated costs were not included in the benefit cost analysis, if included the benefit cost ratio would increase.

- 5) Although prevention of injury and loss of life are an essential aspect of a flood mitigation project, the benefit cost analysis did not include a benefit value. In addition, no costs were projected for loss of time, inconvenience and disruption of businesses. If the costs associated with injuries and loss of life were accounted for in the analysis, the benefit cost ratio number would increase.

The City would be pursuing funding partners should the Reata Wash Study be approved by City Council for advancement. The FCDMC is a potential partner for future cost sharing. Funding from other agencies would reduce City's ultimate cost which would result in a more favorable funding scenario to support a future project.

References:

Reference 1:

www.usace.army.mil/Portals/2/docs/civilworks/budget/ec2012/fy12ecfinal.pdf

Reference 2:

https://www.floodsmart.gov/floodsmart/pages/flooding_flood_risks/the_cost_of_flooding.jsp

Reference 3:

<http://planning.usace.army.mil/toolbox/library/EGMs/EGM16-01.pdf>

Reference 4:

<http://www.fema.gov/benefit-cost-analysis>

The Memorandum: Benefit Cost Analysis (prepared by Wood, Patel & Associates, Inc.) is found in Appendix S of Volume III of the DCR.

All appendices in Volume III are provided on a DVD.

21. SUMMARY AND CONCLUSION

The Reata Wash Study analyzed, identified and recommended a FEMA compliant solution to mitigate flood hazards. The study process also engaged the general public and stakeholders through a public outreach program. A Concept Design Plan was prepared and 18 technical memorandums were developed to convey the technical issues and elements of the study that were required to support a FEMA complaint solution.

The cost of the recommended solution to mitigate flood hazards is estimated at \$48,210,000 (includes CWA mitigation cost and land rights cost). The approximate 5,200 acre FEMA designated floodplain includes approximately 4,600 structures which the majority would be removed from flood hazards. In addition, with the removal of hazards from the FEMA floodplain, flood insurance would no longer be required by the National Flood Insurance Program, for the removed structures (homes).

The Reata Wash Study utilized a benefit cost analysis to evaluate economic advantages (benefits) and disadvantages (costs) of a potential project. The result was a benefit-cost ratio of 2.08, which is derived from a project's total annualized net benefits divided by its total project annualized cost. The benefit cost ratio is a numerical expression of the cost effectiveness of a project. A project is considered to be cost effective when the benefit cost ratio is 1.0 or greater, indicating the benefits of a prospective hazard mitigation project are sufficient to justify the costs. Results of the Reata Wash Study's benefit cost analysis indicate the benefits of flood hazard mitigation are sufficient to justify consideration for a project.

In conclusion, the Reata Wash Study verified, identified or determined the following:

- Support of the community, as evidenced by written responses and feedback during open houses and meetings
- A recommended solution that mitigates flood hazards and is FEMA compliant
- The recommended solution was verified as cost effective through a benefit cost analysis

Before the completion of the City sponsored Reata Wash Study, a comprehensive solution or document outlining a FEMA compliant approach did not exist. The Reata Wash Study provides a holistic FEMA compliant solution to the flood hazards occurring in the approximate 5,200 acre FEMA floodplain and its associated approximate 4,600 structures. The City would be pursuing funding partners to support a future project should the Reata Wash Study be approved by City Council for advancement, which has not occurred as of the date of this document.