



Approved: July 1986
Updated: March 2004



Downtown Plan Urban Design & Architectural Guidelines

**DOWNTOWN SCOTTSDALE
URBAN DESIGN AND ARCHITECTURAL GUIDELINES**

**CONTENTS
PREFACE**

I.	DOWNTOWN URBAN DESIGN.....	2
II.	GENERAL DOWNTOWN GUIDELINES	
A.	SITE DEVELOPMENT	
	TYPE 1 AND 2 DEVELOPMENT AREAS:	
A1.	RELATIONSHIP OF NEW TO EXISTING DEVELOPMENT.....	7
A2.	ACTIVE STREET FRONTAGES.....	9
A3.	COURTYARDS AND PASSAGES.....	10
A4.	PARKING FACILITIES.....	12
A5.	BUILDING EQUIPMENT AND SERVICES.....	14
	TYPE 1 DEVELOPMENT AREAS:	
A6.	THE BUILDING - STREET EDGE.....	15
A7.	FINE GRAIN CHARACTER.....	17
	TYPE 2 DEVELOPMENT AREAS:	
A8.	THE CONTINUITY OF STREET SPACES.....	18
A9.	THE BUILDING SETBACK ZONE.....	19
A10.	THE LINKAGE OF NEIGHBORING DEVELOPMENTS.....	21
B.	BUILDING FORM	
B1.	REDUCTION OF APPARENT SIZE AND BULK.....	23
B2.	COVERED WALKWAYS.....	27
C.	ARCHITECTURAL CHARACTER	
C1.	PROPORTION AND SCALE.....	29
C2.	BUILDING MATERIALS.....	30
C3.	COLOR AND TEXTURE.....	31
C4.	ARCHITECTURAL DETAIL.....	32
D.	LANDSCAPE CHARACTER	
D1.	STREETS.....	34
D2.	SITE SPACES.....	37
D3.	PLANT SELECTION.....	39

III. GUIDELINES FOR SPECIAL DISTRICTS

A. OLD TOWN.....	41
B. WEST MAIN.....	43
C. FIFTH AVENUE.....	53
D. MARSHALL WAY - CRAFTSMAN'S COURT.....	58
E. THE COUPLET.....	63

APPENDIX A: PLANT SELECTION GUIDE

Appendix A is contained in a separate document

PREFACE

Downtown Scottsdale has many virtues that attract residents, shoppers and visitors who find it different from and more desirable than other places in the metropolitan area. However, some of these virtues may disappear if new development is not carefully related to what is existing.

The primary purpose of these Guidelines is to influence the general character of new projects so Downtown will preserve its present qualities as it develops. A second purpose is to identify issues of City concern that should be considered by owners, developers, architects and builders as they prepare proposals for City staff and Development Review Board consideration.

The Guidelines list recommendations for site development, building form, architectural and landscape character to assure that new development contributes to Downtown urban design goals and is compatible with the character of existing Downtown districts.

I. DOWNTOWN URBAN DESIGN GOALS

1. PROTECTS THE EXISTING UNIQUE CHARACTER OF OLDER DOWNTOWN DISTRICTS AND PROMOTE CONTINUITY OF CHARACTER IN NEWER ONES.

The identity of individual districts is a particular strength of Downtown Scottsdale. The older districts of Old Town, West Main and Fifth Avenue provide an important link to Scottsdale's history. New projects in these areas should respect existing development scale and architecture, carefully reinforcing present character. In newer districts where greater diversity now exists, individual projects should be designed to contribute to district design goals and reinforce the City's intent to strengthen community character.

2. STRENGTHEN PEDESTRIAN CHARACTER AND CREATE NEW PEDESTRIAN LINKAGES.

Downtown's pedestrian character distinguishes it from other places in the Valley. It serves as an attraction to visitors and an important part of the City's heritage valued by residents. All new Downtown projects should emphasize and extend this pedestrian character. An attractive network of clear pedestrian linkages between the separate Downtown districts should be developed, making it possible for enjoyable walks through a wider area of Downtown.

3. CREATE A COMPACT DOWNTOWN WITH AN INTENSIFIED AND DIVERSE MIX OF ACTIVITIES.

Downtown Scottsdale can accept growth and prosper if it keeps its pedestrian character and presents an attractive alternative to the automobile-oriented nature of other places in the metropolitan area. Downtown should attract housing, hotels, offices and other activities to complement its present specialty shopping reputation. The Development area should be compact and intense while maintaining present pedestrian scale.

4. CREATE A HIGH LEVEL OF EXPECTATION IN THE QUALITY OF DOWNTOWN ARCHITECTURE.

Downtown building should be influenced by the regional climate, character of the desert landscape, and a concern for human size and scale. The Design Guidelines define desert landscape, and concern for human size and scale. The Design Guidelines define principles for reducing apparent bulk and size by treating building forms and compositions of smaller parts. Regional architectural traditions such as the protection of openings from the sun, strong shade and shadow patterns, massive character of walls simplicity of materials and colors, and frequent use of courtyards are stressed.

5. CREATE A DISTINCT DOWNTOWN LANDSCAPE CHARACTER.

Downtown's people-oriented character should be reinforced by planting, street furniture, decorative paving and ornamental lighting. The image created by these landscape elements should be that of a desert oasis, providing an abundance of shade, color, varied textures and forms.

DOWNTOWN URBAN DESIGN GOALS

6. **CONTINUE AND EXPAND THE TRADITION OF DOWNTOWN'S COVERED WALKWAYS.**
The covered walkways are a key part of Downtown's architectural heritage. The walkways unify diverse fronts, provide people with shaded protection from the sun, and further serve as a consistent architectural element of pedestrian scale. Covered walkways are required in the Pedestrian Overlay District and are strongly encouraged in all areas as a unifying urban design element, signaling Scottsdale's special pedestrian character.
7. **CREATE COHERENT AND CONSISTENT STREET SPACES.**
Downtown's streets, building setback areas and building frontages should work together to create a unified image. Site planning of individual projects should give priority to establishing complementary and supportive relationships with neighboring properties and the urban design goals of their districts.
8. **IMPROVE ACCESS TO CONVENIENT DOWNTOWN PARKING.**
Shopping areas need parking garage nestled close to them. Automobile access from popular streets should be direct and simple. Structured parking, if properly located will contribute to Downtown's compactness and serve the convenience of visitors without intruding on the pedestrian environment.
9. **EXPAND THE DOWNTOWN TROLLEY SYSTEM**
The trolleys are a promising method of moving Downtown visitors. They provide linkages between Districts, strengthen pedestrian choices and reduce traffic congestion. The Trolleys should be emphasized as a key to solving Downtown's traffic circulation problems. Individual projects should be planned to accommodate its expansion.
10. **ADDRESS THE SPECIAL OPPORTUNITY OF THE COUPLET.**
The two arterial streets known as 'the Couplet' (Drinkwater Boulevard and Goldwater Boulevard) provide improved access to Downtown without disrupting the character of the specialty retail districts. Continuity of character along the Couplet system is to be emphasized in the building profiles and landscape design of new developments, as well as in the detailed design of lighting, planting, sidewalks, graphics and street furniture in the public right-of-way.

DOWNTOWN DEVELOPMENT AREAS

Downtown is divided into two general Development Areas:

TYPE 1: (COMPACT) DEVELOPMENT AREA

TYPE 2: (INTERMEDIATE) DEVELOPMENT AREA

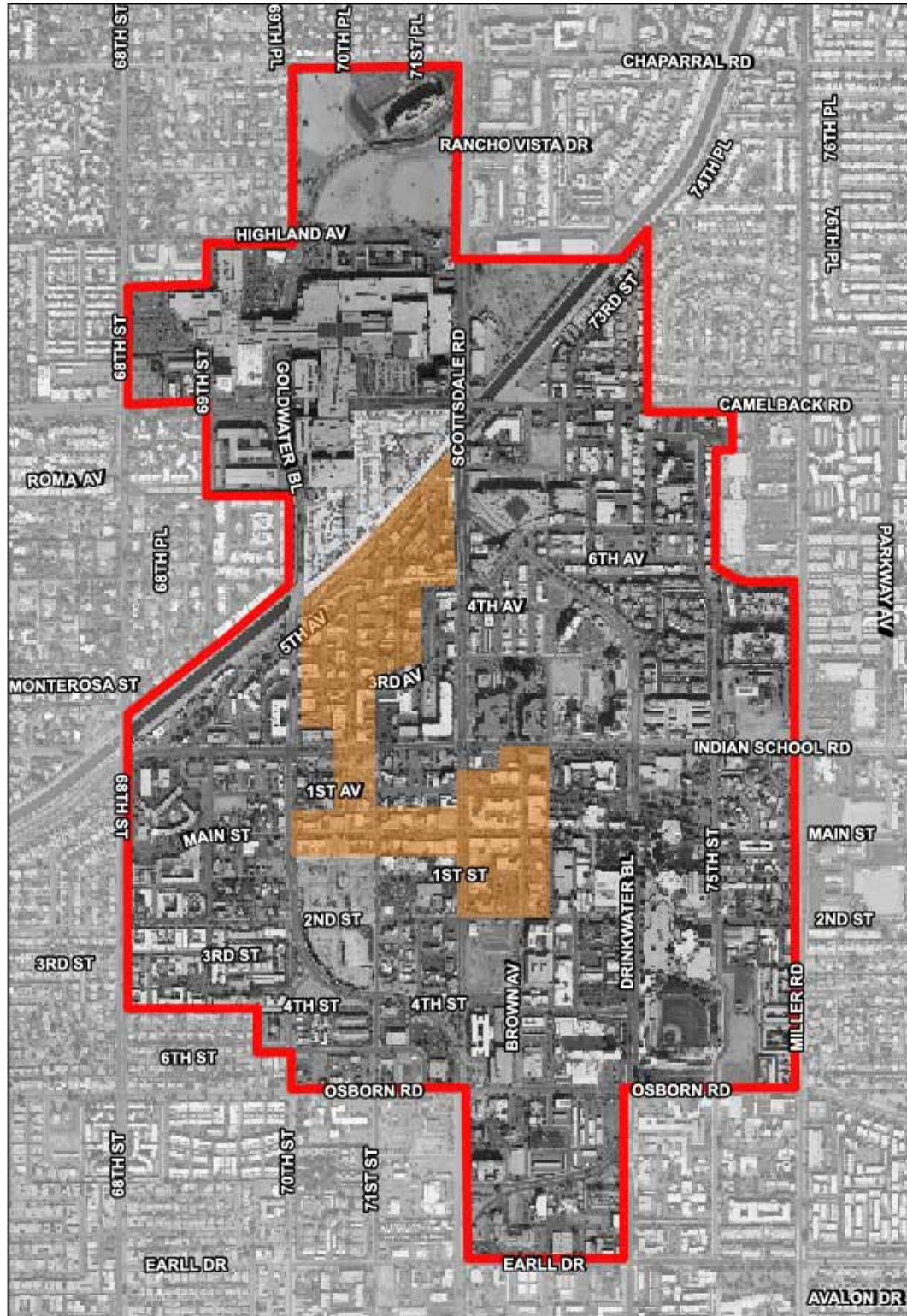

Aerial Flight Date 12/2001

DOWNTOWN DEVELOPMENT AREAS

TYPE 1 (COMPACT) DEVELOPMENT AREAS

The Type 1 Development areas contain most of the Old Town, West Main and Fifth Avenue and Marshall Way - Craftsman's Court districts. Urban design goals for these districts are:

- Preservation of existing pedestrian-scale and strengthening of fine-grain building character.
- Development of strong pedestrian linkages between districts.
- Improvement of the quality and continuity of "street spaces".
- Compatibility of architectural character.

TYPE 2 (INTERMEDIATE) DEVELOPMENT AREAS

The TYPE 2 Development Areas comprise the major portion of Downtown. The size of development sites in Type 2 Areas varies widely, ranging from small infill projects to large assemblies of land for multi-building developments. Urban Design goals for these districts are:

- Development of unified street spaces with consistent design principles for the building setback zone.
- Development of pedestrian and vehicular linkages between adjacent large projects.
- Consistent planting design principles to achieve visual structure on important arterial streets.
- Careful handling of architectural form to reduce the apparent size and bulk of larger buildings.

II. GENERAL DEVELOPMENT GUIDELINES



A. SITE DEVELOPMENT

A1. RELATIONSHIP OF NEW TO EXISTING DEVELOPMENT
TYPE 1 AND 2 DEVELOPMENT AREAS

- All development proposals should show evidence of coordination with the site plan, arrangement of building forms and landscape design and facade patterns of neighboring properties.
-

The degree to which existing buildings must be considered in the design of a new project will depend upon the value, architectural quality and estimated tenure of the existing structures as well as the particular requirements of the new project. New buildings must coexist with their neighbors. While a firm rule is not possible, every new proposal must demonstrate it has considered the contextual influences of neighboring properties and has made a diligent effort to orchestrate careful relationships between new and old.

Drawings, models or other graphic communications presented to the Development Review Board and other City review agencies should show neighboring buildings and important features of adjacent sites. Existing features should be shown in sufficient detail to enable evaluation of the relationship of the proposed development to its context. As a general rule, perspective views of the proposed project and its immediate neighbors as seen from the street, sidewalk or other public places should be provided.

Specific consideration should be given to the following:

1. Site plan arrangement of adjacent properties.

The site organization should respect the arrangement of building, open space and landscape elements of adjacent sites. When possible, building and open spaces should be located for mutual benefit of sunlight, circulation and views.

It is desirable for open spaces at the edge of the site to visually connect with open spaces on the adjacent site. The effect may be reinforced by shared circulation spaces such as a common entry court, by linking courtyards and patios, and by coordinating or repeating landscape elements such as enclosing courtyard walls and planting.

Example
Development Site

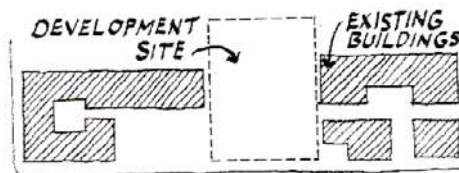

Not
Recommended

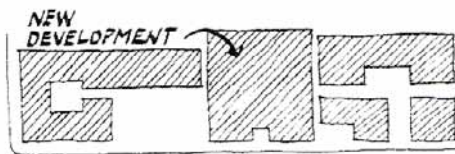

Recommended

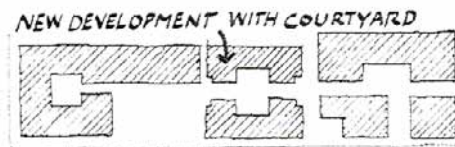

A1. RELATIONSHIP OF NEW TO EXISTING DEVELOPMENT

2. Form and height

Efforts to coordinate the form and height of adjacent structures are encouraged.

It is often possible to adjust the height of a wall or cornice line to match that of an adjacent building. Similar visual linkages may be achieved by lining up window bands, belt courses or mouldings.

A repeated architectural element such as a covered walkway, recessed base or similar roof form may be used to provide a visual linkage between old and new.

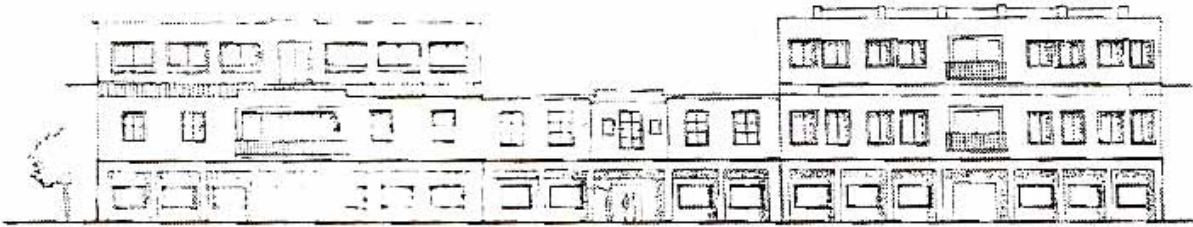

Buildings related by a common base story element

A2. ACTIVE STREET FRONTAGES

TYPE 1 AND 2 DEVELOPMENT AREAS

- Design active building frontages to create inviting indoor and outdoor spaces visible from the sidewalk and street.
- In office and commercial zones, locate shops, restaurants and other activities which show signs of life along the ground level at the street. Avoid blank walls, parking and other "dead" activities from street frontages.
- Provide frequent building entrances along public streets.

Active building frontages are an essential ingredient in Scottsdale's desire to strengthen Downtown's pedestrian character. Buildings should provide openings at ground level to allow views of display windows by pedestrians.



Frequent building entrances along the street are encouraged. In the Type 1 Development Areas, at least one entrance should be provided for every 50 feet of building frontage. This interval should also be a goal in the Type 2 Development areas, with 100 feet between entrances observed as a maximum. Side and rear building entrances should always be accompanied by a front, street-facing entrance.

Discouraged.
Long distance between entrances.

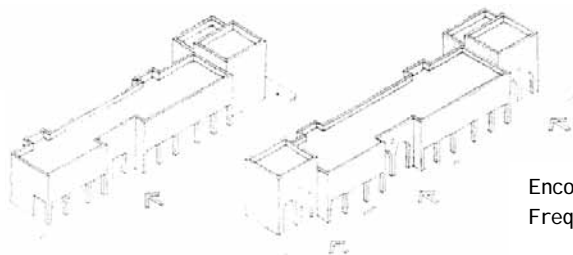

Encouraged.
Frequent street entrances.

A3. COURTYARDS AND PASSAGES TYPE 1 AND 2 DEVELOPMENT AREAS

- All new developments are encouraged to incorporate courtyards and other outdoor pedestrian spaces into their site plans and to establish linkages with the outdoor spaces of neighboring buildings and sites.
-

Downtown Scottsdale has the potential to develop a series of linked outdoor spaces that work together to bind separate buildings, building groups, and districts together. Covered walkways, shaded patios and courtyards contribute to a rich pedestrian environment that can be enjoyed through most months of the year.

1. Location of Courtyards.

A courtyard may serve as the focus of site building, or may lead to other activities away from the street.

It is preferable that courtyards be partially-visible from the street or linked to the street by a clear circulation element such as an open passage or covered arcade.

The edges of courtyard space should contain retail shops, restaurants, offices or other activities that show signs of life. Blank walls and dead spaces without pedestrian interest should be minimized.

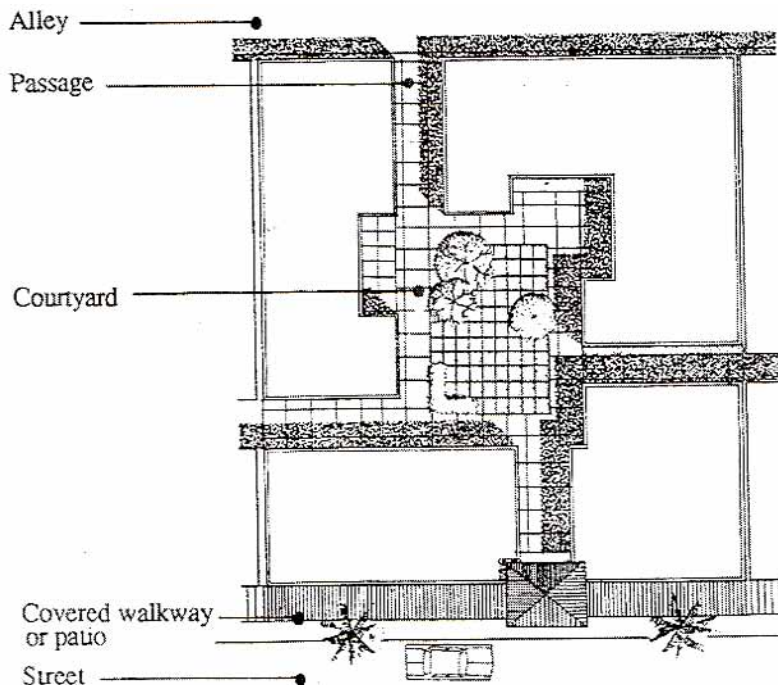

A3. COURTYARDS AND PASSAGES

2. Characteristics of courtyards that are encouraged:

- Sculpture or fountain as a focal point.
- Movable seating and tables.
- A choice of shaded and sunny areas.
- Several doors opening onto the courtyard.
- Ability to secure at night.
- Variety of texture and color.
- Covered and uncovered outdoor passages.

3. Outdoor passages and linking spaces.

Outdoor passages and courtyards that provide links between neighboring sites and buildings are encouraged throughout the Downtown pedestrian districts.

Planned Block Developments provide a special opportunity to establish a network of internal pedestrian connections between adjacent properties. City review of Planned Block proposals will give high priority to this objective.

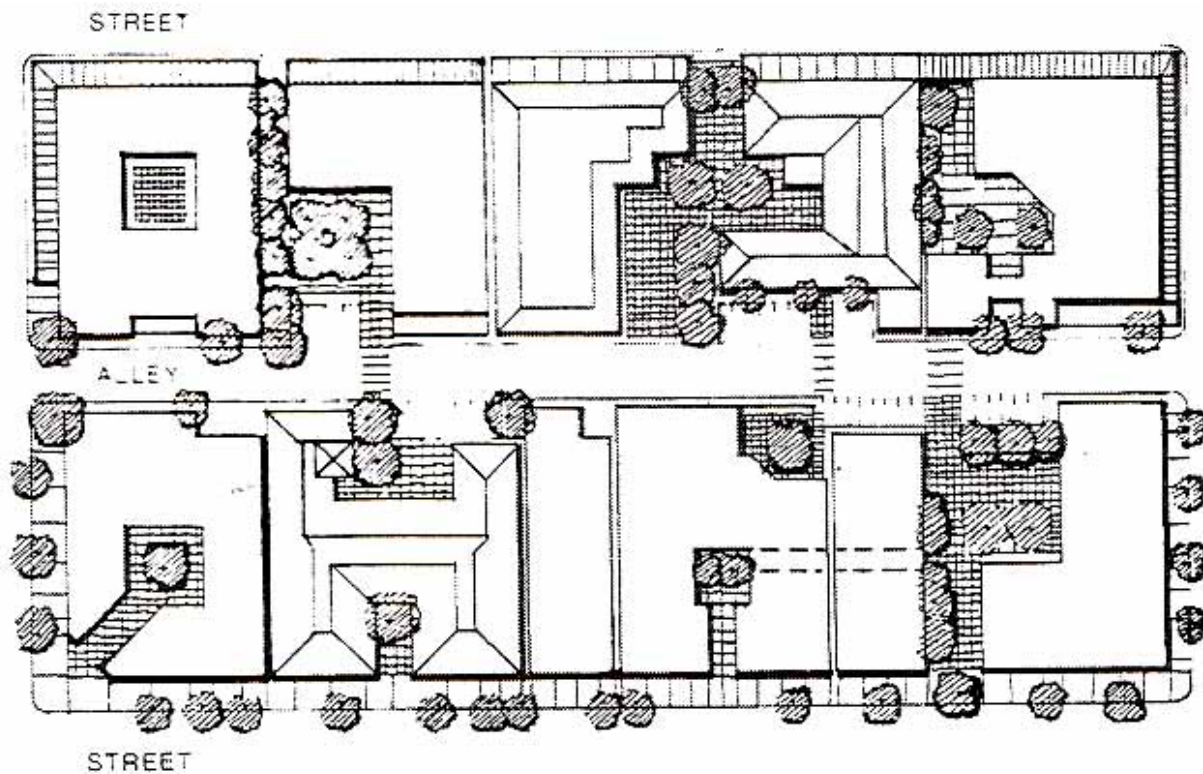

A4. PARKING FACILITIES

TYPE 1 AND 2 DEVELOPMENT AREAS

- Minimize the visual impact of parking structures and parking lots by locating them at the rear or interior portions of building sites.
- When parking structures must be located at the street edge, use the ground level frontage for commercial space or as a landscaped patio space.
- Parking access from alleys and side streets is desired. The number of entrances to parking facilities from other streets, especially major arterials, should be kept to a minimum.

This Guideline should be observed for all parking facilities except public parking used primarily by shoppers.

1. Parking structures

Parking structures which must be located on public street frontages should:

- Minimize the street frontage of the structure by placing its short dimension along the street edge.

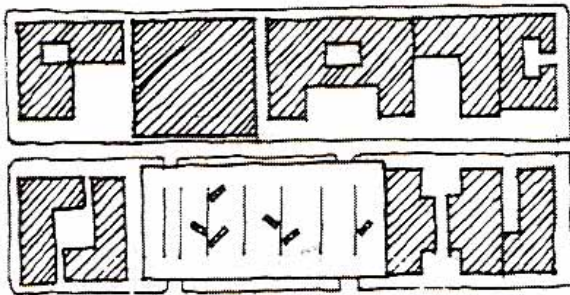

Discouraged

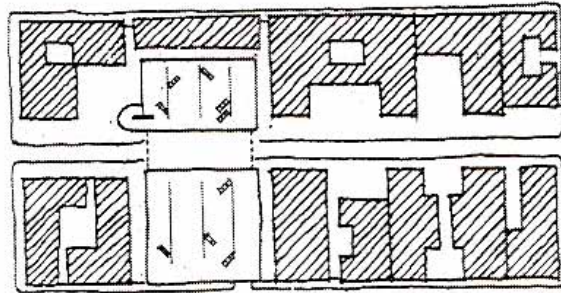

Encouraged

Parking structure with reduced street frontage

- Develop activities such as shops, offices or other commercial space along the ground level of street frontage.
- When this is not possible, provide a planted patio space between the structure and the street.

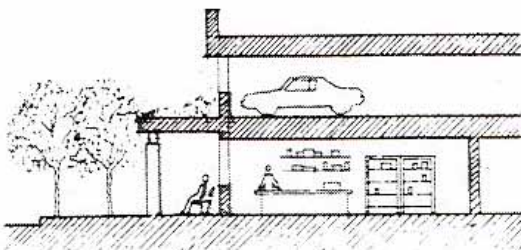

Parking structure with ground floor shop.

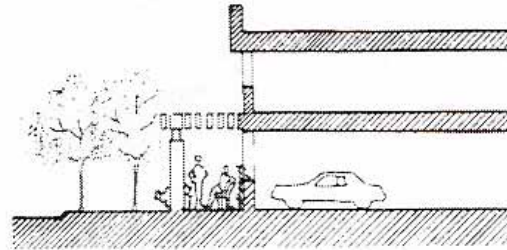

Parking structure with planned patio space.

A4. PARKING FACILITIES

2. Surface Parking Lots

The Downtown zoning ordinance requires a minimum 4 foot deep landscaped buffer between a parking lot and street frontage, a minimum 15% parking area landscaping requirement, and a 3 foot high continuous screen around the parking lot perimeter. In addition to these requirements, tree canopies that provide partial shade are encouraged to relieve heat build-up and screen parking areas from view. To provide a canopy, one of the following methods is recommended.

- A planted break at least 4 feet wide at a minimum interval of 6 parking spaces in a row.
- One tree at a minimum interval of 3 parking spaces in a row located in the center of the parking bay.

Maintain a minimum 5 foot wide landscaped buffer zone or pedestrian walkway between buildings and parking lots.

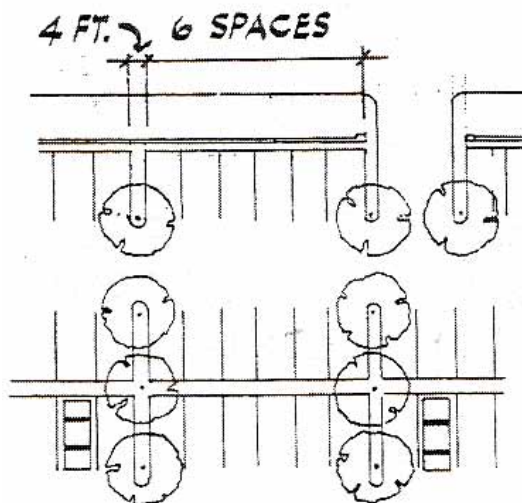

Parking with 4 ft. planted break.

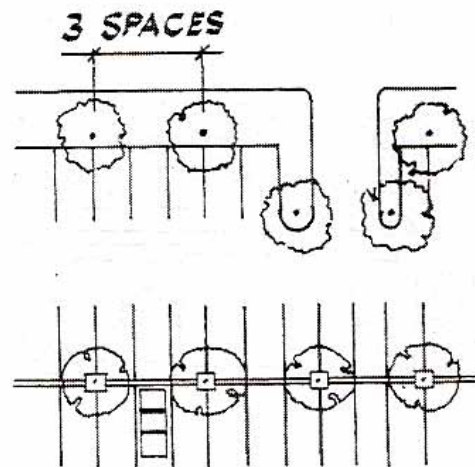

Parking with planter or grate.

A5. BUILDING EQUIPMENT AND SERVICES

TYPE 1 AND 2 DEVELOPMENT AREAS

- Locate service and loading zones to minimize visibility from public streets.
- Mechanical and electrical equipment, solar collectors, satellite dishes and communications equipment should be concealed from view of public streets and neighboring properties.

On Downtown building sites served by the alley system, locate all serve-delivery entrances, loading docks and refuse collection facilities in the alley area.

On sites not served by an alley, locate service areas to the rear, side or at an internal location where visibility from public streets and windows of neighboring buildings will be minimized.

In addition to proper location, service areas should be designed to present the best possible appearance within the limits of their function. Pedestrians frequently use the alleys for "short cuts" between blocks, or for access to parking. Projects should provide for the possibility that some Downtown alleys will be improved for secondary pedestrian circulation.

Refuse collection areas and dumpster should be enclosed by a screen wall of durable material. Planting to screen views from streets and neighboring properties is encouraged.

A6. THE BUILDING-STREET EDGE

TYPE 1 DEVELOPMENT AREAS

- Building in Type 1 Development Areas should create continuous building-street edges without interruption by long spatial gaps.
 - Maintain pedestrian interest by minimizing blank walls and other dead spaces at the ground floor.
-

The purpose of this Guideline is to preserve and improve the character of existing Downtown pedestrian districts. The success of these districts depends on their ability to offer a continuous pedestrian activity in an uninterrupted sequence.

In Type 1 Development Areas, the zoning ordinance requires a minimum of 50% of the ground level front elevation of the building to be placed on the setback line. Projects should strive to exceed this minimum by placing as much of the front elevation as possible on the building line.

1. Within the Downtown Pedestrian Overlay District, where covered walkways are required, the following building-street edges are encouraged:
 - Continuous building edge with continuous covered walkway over the sidewalk.



- Shallow courtyard behind the covered walkway. The courtyard creates a space for entry and outdoor activities.

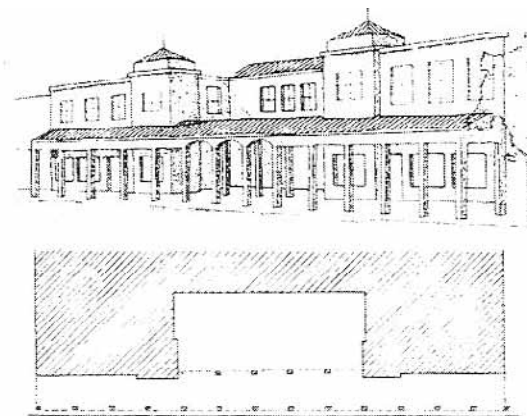

A6. THE BUILDING-STREET EDGE

2. In Type 1 areas outside the Pedestrian Overlay District, desired building-street edges are:

- Continuous building edge with covered walkways or other shaded circulation space tucked under the building.

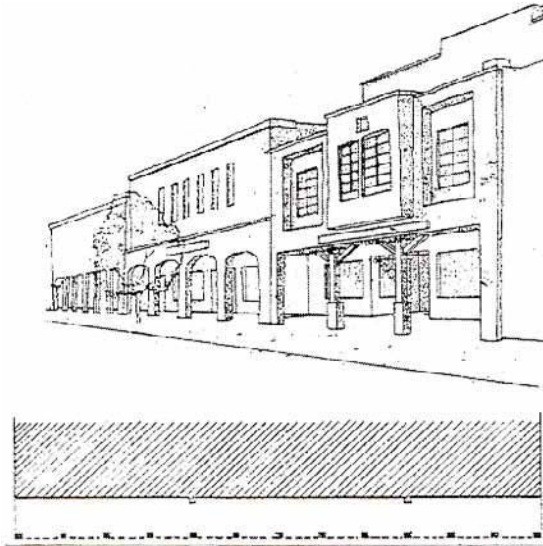

- Shallow courtyard or patio space defined by a low wall at the building line.

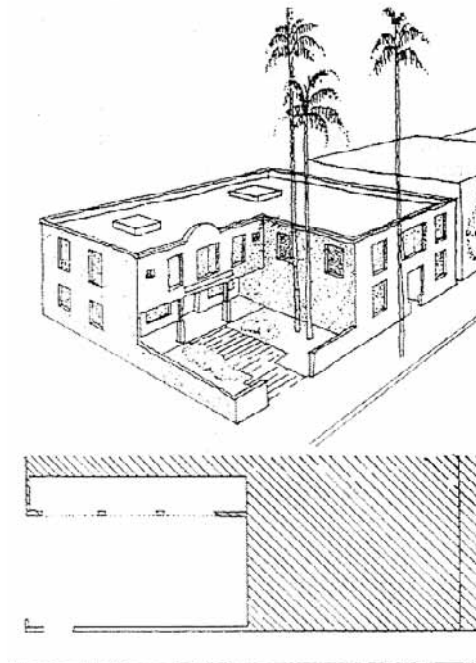

A7. FINE GRAIN CHARACTER

TYPE 1 DEVELOPMENT AREAS

- Projects in Type 1 Development Areas should preserve existing street character by reducing apparent building width and bulk.
 - Strengthen pedestrian interest by providing frequent shop and building entrances along street frontages.
-

Downtown's older Districts are an important link to Scottsdale's small-town history and a source of its attraction to both residents and visitors. New development in these districts should continue the present pedestrian scale and fine-grain pattern established by existing buildings.

1. **Apparent Building Width**

Buildings over 50 feet wide are encouraged to divide their elevations into smaller parts. This can often be accomplished by a change of plane, projection or recess, or by varying a cornice or roofline. The apparent width of buildings should be limited to 100 feet.

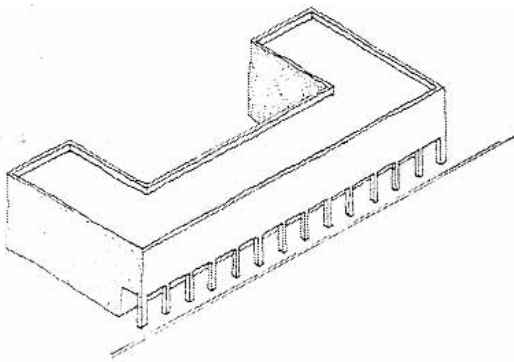

Unacceptable.

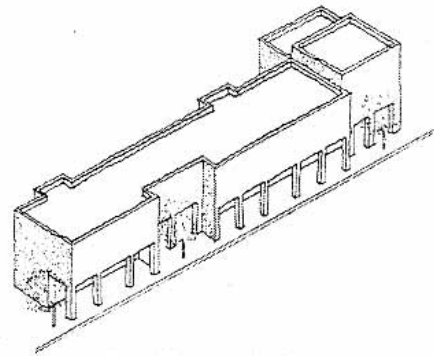

Desired.

2. **Apparent Storefront Width**

Similar attention should be given to reduce apparent storefront width. The zoning ordinance requires an apparent storefront width of less than 50 feet in the Pedestrian Overlay District. The limit should be observed as an objective for building in Type 1 Development areas.



A8. THE CONTINUITY OF STREET SPACES

TYPE 2 DEVELOPMENT AREAS

- Buildings should create consistent street setback patterns by locating a maximum amount of their front elevation on the setback line.
- The preferred building-street relationship is to place buildings parallel to the street.

The intent of the Guidelines is to create coherent and unified street spaces throughout Downtown Scottsdale.

"Streets spaces" include both the public right-of-way and adjacent building setback zone. The network of street spaces establishes the basic scale and character of the Downtown environment. Consistent street spaces can pull together Downtown's separate buildings and developments into a unified whole.

Building location and plan form should strive for a consistency of setback pattern on each block. In the Type 2 Development Areas, the zoning ordinance requires a minimum of 25% of the building front elevation to be placed on the setback line. Site planning should strive to exceed this minimum and reduce gaps of undefined space between adjacent buildings. Variation of the building-street edge should be carefully-controlled. Avoid buildings whose primary mass is sited at an oblique angle to the street.

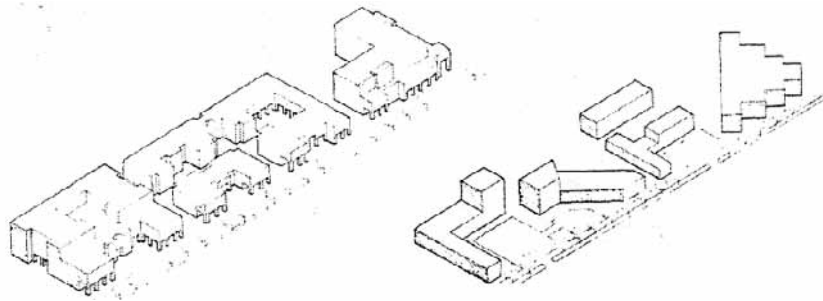

Desired: Consistent setback pattern.

Unacceptable.

Corner Buildings

Corner buildings should make a strong tie to the building lines of each street. The primary mass of the building should not be placed at an angle to the corner. This does not preclude angled or sculpted building corners, or an open plaza at the corner.

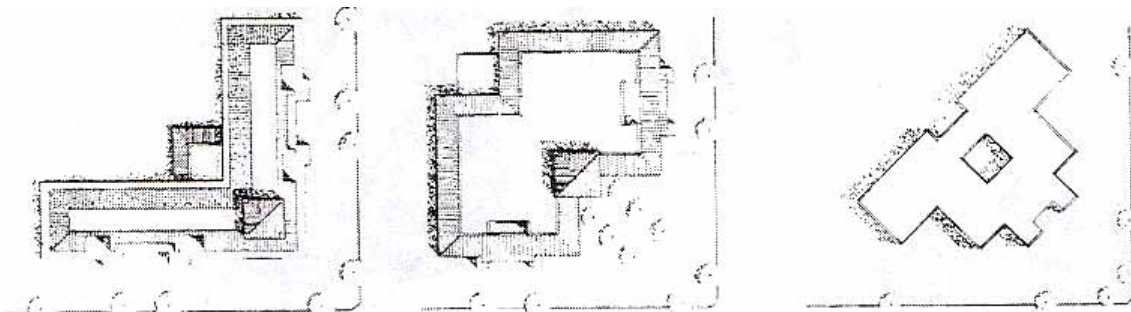

Desired.
Strong corner building
tied to both streets.

Desired.
Plaza space at corner.

Unacceptable.
Primary building mass
at angle to corner.

A9. THE BUILDING SETBACK ZONE

TYPE 2 DEVELOPMENT AREAS

- The building setback zone should be developed as a "patio" landscape designed primarily for pedestrian activity and enjoyment.
 - Expanses of lawn should be avoided.
 - On major Downtown arterial streets (Camelback, Scottsdale, and Indian School Roads and the Couplet), locate the sidewalk away from the street and provide a buffer of trees, shrubs and street furniture to give pedestrians a sense of protection from moving automobiles.
-

The character of the building setback zone must be unique if Downtown Scottsdale is to continue its reputation as being pedestrian-oriented. The intent of this Guideline is to establish basic principles that strengthen Downtown's pedestrian opportunities.

The building setback zone is a 3-dimensional layer of space between the building and planned curb line. In most suburban development, the design of this space takes a different character in each new building and development. Seldom do neighboring site and landscape designs relate to one another or consider the cumulative design of the street on which they take place. This discontinuous pattern is to be avoided Downtown.

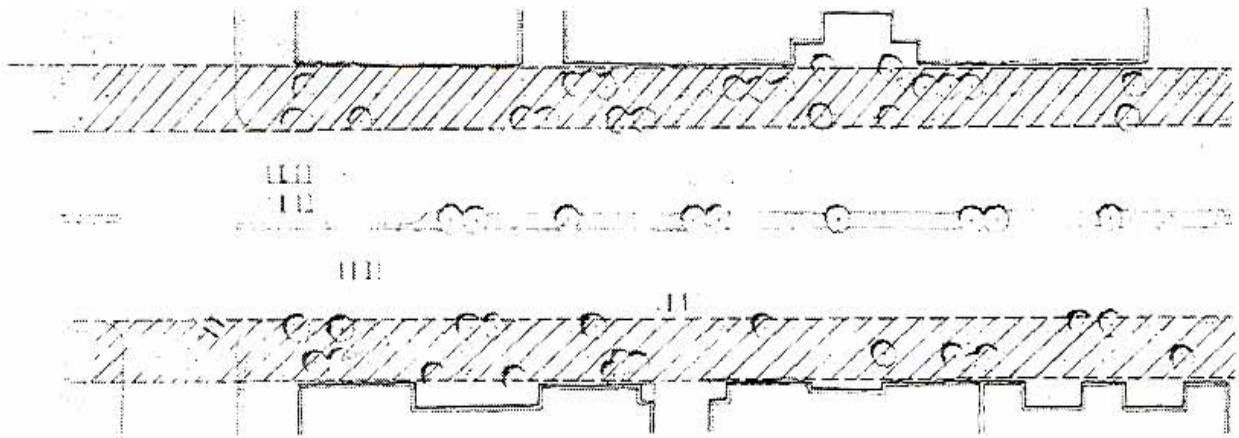

Building setback zone.

A9. THE BUILDING SETBACK ZONE

The space of the setback zone should be more like a "patio" than a front lawn. It should provide pedestrians with a buffer from passing traffic, shaded protection from the sun, and a rich variety of experiences and choices.

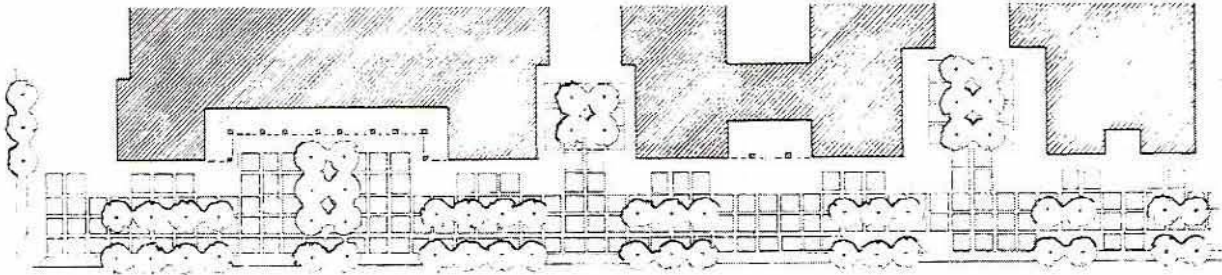

Building setback zone with patio landscape.

The following characteristics are desirable:

- More paved than unpaved area. Paving with a variety of textures and colors.
- Paving continuous from curb to building except for planters, planter beds, trees and fountains.
- The planting plan along street edges should be linear and rhythmic with occasional contrasts and accents.
- Site furnishings scaled to human size.
- On major arterials, there should be a buffer between the pedestrian and street: bollards raised planter beds, and site furnishings such as lamp posts, inward-facing benches fountains, low walls and bike racks.
- Lighting at pedestrian height to supplement street lighting.
- Trees scaled and located to create shade for pedestrians and for appreciation by passing motorists.
- Grass should be used only in small areas.
- Geometric patterns (including circles) are preferred instead of organic shapes.

Landscape Guidelines

General Guidelines for Downtown landscaping have been established and are given in Section D. "Landscape Character". Landscaping Guidelines for special Downtown districts are listed in Part III.



A10. THE LINKAGE OF NEIGHBORING DEVELOPMENTS

TYPE 2 DEVELOPMENT AREAS

- Establish pedestrian, vehicular, parking and trolley connections between adjacent developments.

The purpose of this Guideline is to establish internal linkages between neighboring buildings and sites. By enabling pedestrians and drivers to travel between adjacent destinations without re-entering streets, Downtown traffic congestion on major arterials can be reduced.

This Guideline applies to Planned Block Developments and large developments, generally projects over 2 acres located on major arterial streets.

1. Vehicular connections between adjacent properties may be established by:
 - Connecting streets and drives
 - Coordination of parking structure and parking lot entrances
 - Common service/delivery areas
 - Shared parking structures and parking lots
 - Linkages between parking lots and parking structures
2. Site planning and site facilities to accommodate an expanded Downtown trolley system should be provided for by:
 - Location of a trolley stop on or at the edge of the site.
 - Where feasible, provisions of a trolley path through the site, linking adjacent sites.
 - Shared trolley stop with neighboring sites when such an arrangement is possible.
 - A combined pedestrian and trolley path where appropriate.
3. Clear pedestrian and visual paths between neighboring buildings and sites should be established with:
 - Covered walkways, a sequence of courtyards and patios, a unifying landscape pattern and consistent paving materials.
 - Minimal interruption of pedestrian paths by automobile circulation, parking lots and service areas.

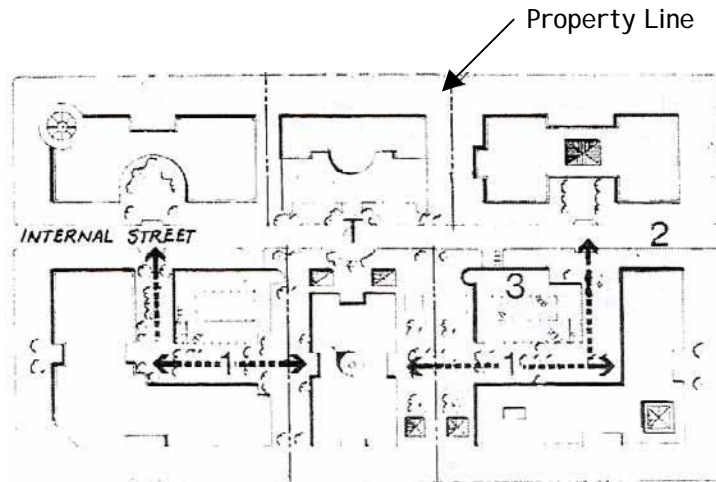

1. Clear pedestrian linkages.
2. Common internal street.
3. Shared parking structure.
- T Common trolley stop.

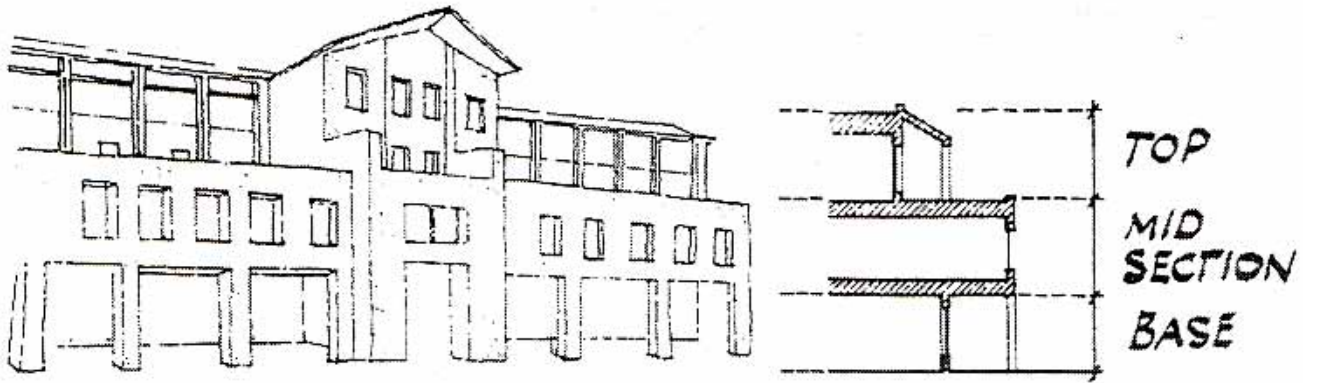

B. BUILDING FORM

B1. REDUCTION OF APPARENT SIZE AND BULK

Downtown buildings of three or more stories should be designed as carefully-orchestrated compositions of smaller parts. Every building should reduce its perceived height and bulk by dividing the building mass into smaller-scale components.

Large or long continuous wall planes should be avoided. As a general principle, building surfaces over two stories high or 50 feet in length should be relieved with a change of wall plane that provides strong shadow and visual interest.

Suggested methods of reducing the apparent size and bulk of larger buildings are illustrated. Although these methods are encouraged, other approaches that achieve the same objectives are acceptable.

1. HORIZONTAL COMPOSITION: THREE-PART ORGANIZATION OF BUILDING FORM

A traditional principle of architectural form used for centuries has been to organize the mass of a building into distinct horizontal parts that express a sense of base, midsection and top. This is an effective way to develop a more sculptured quality of architectural form.

Two local buildings which successfully use this idea are the Arizona Biltmore in Phoenix and the Mission Palms Hotel in Tempe.

The Biltmore uses deep recesses on the ground level to develop a strong, shadowed base plane that firmly ties the building to the ground site. Its top story is reduced in size, lightening the feel of the building mass. The expression of the top is reinforced by a gently-sloped roof and overhang which recesses the upper story window in a continuous band of shadow. Between the base and top, the mid-section of the building catches strong sunlight to contrast with the darker base and shadowed eave line.

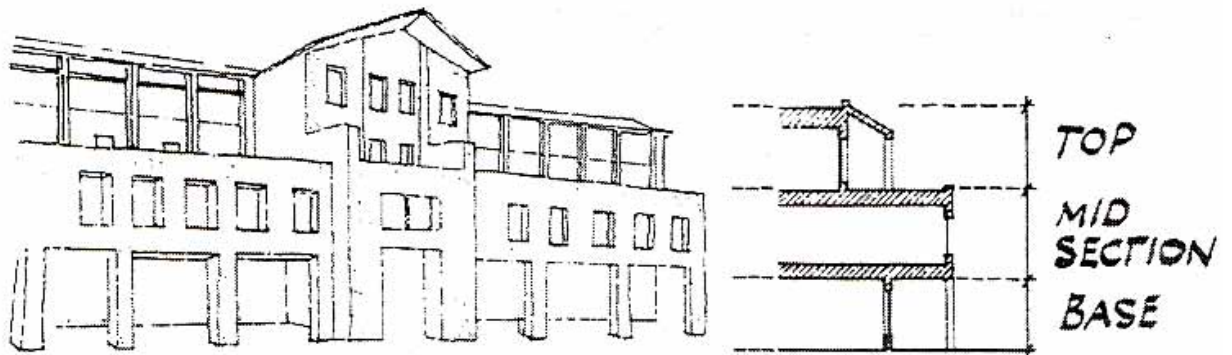

B1. REDUCTION OF APPARENT SIZE AND BULK

The Mission Palms is a larger and bulkier building, but its recessed ground-level arcade develops a strong sense of a base similar to the Biltmore. The top story of the building is differentiated from its base by a change in window spacing and a modest roof overhang that casts a strong, continuous shadow over the upper-story windows. The entrance portals and corner elements are emphasized to relieve the long horizontal line of the roof.

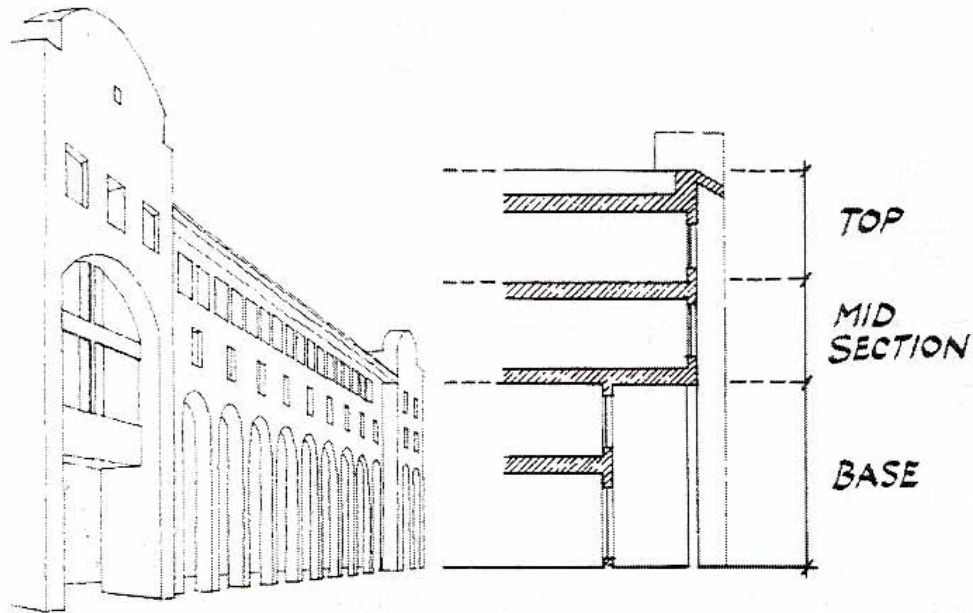

THE BUILDING BASE

The building base should be a shaded element that establishes a strong connection to the ground and site. A covered walkway, arcade or other circulation element set in deep shadow and carefully integrated with the total building form is most desirable.

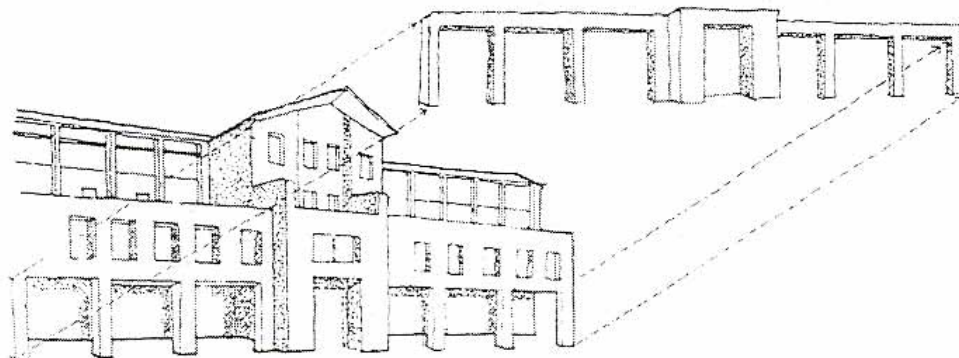

B1. REDUCTION OF APPARENT SIZE AND BULK

THE BUILDING MID-SECTION

The building mid-section is expressed as the main "body" of the building. The preferred way of handling the mid-section is to treat the body of the building as a solid wall with deep-recessed windows or groupings of recessed windows.

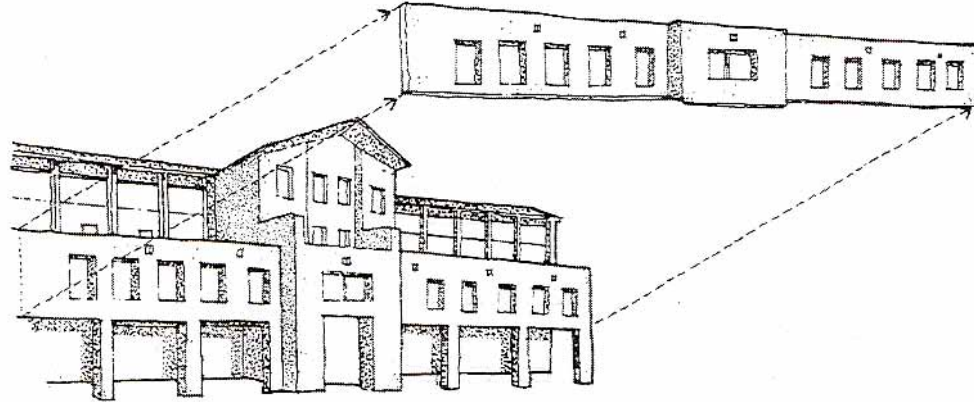

THE BUILDING TOP

The building should differentiate its top story by developing a lighter character. As a general principle, upper levels should reduce floor area and building mass, appearing less bulky.

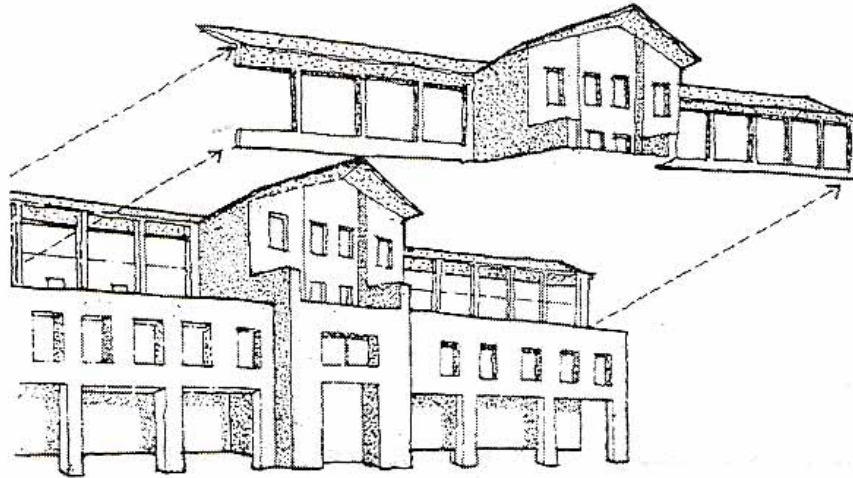

Following are examples of articulating a building top:

- A tapered or sculpted roof form that develops a silhouette against the sky.

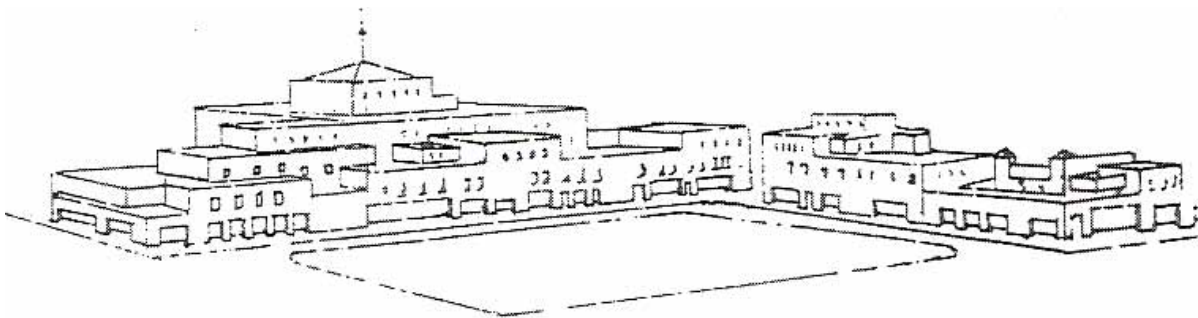

B1. REDUCTION OF APPARENT SIZE AND BULK

- A strong band of shadow created by a recessed gallery, groupings or recessed windows or generous roof overhang.

2. COMPOSITION OF RECESSES AND PROJECTIONS

Recesses and projections are encouraged to divide horizontal planes of the building into smaller-scale elements and to produce strong areas of shade and shadow.

- Recesses may be used to define courtyards, entries or other outdoor spaces along the perimeter of the building.

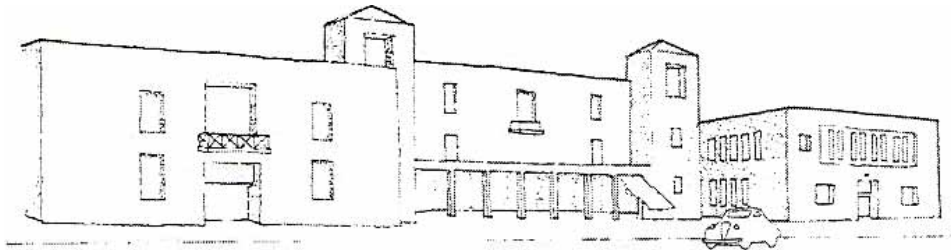

Recessed courtyard to divide building mass into smaller parts

- Recessed balconies, porches and loggias create a sense of depth in the building wall, contrasting surfaces exposed to the sun with those in the shadow. The strong, alternating light and dark pattern is a distinctive quality of regional architecture in the Southwest.
- Projections may be used to emphasize important architectural elements such as entrances, bays, stair towers, balconies and verandas.

3. SPECIAL PROVISIONS FOR HIGHER BUILDINGS

Buildings over 3 stories high, especially those built at or near the 72 foot maximum, should reduce the visual impact of taller elements as viewed from the street.

B2. COVERED WALKWAYS

- All downtown buildings are encouraged to provide a covered walkway or other form of shaded base on street-facing elevations
-

Scottsdale's tradition of covered walkways is an important part of the community's architectural heritage. The walkways provide pedestrians with relief from the sun, buffered protection from the street and are a consistent architectural element scaled to human size. They help unify Downtown streets in the Old Town, West Main and Fifth Avenue Districts.

New buildings throughout Downtown are encouraged to provide a covered walkway or other form of shaded base along their street frontages.

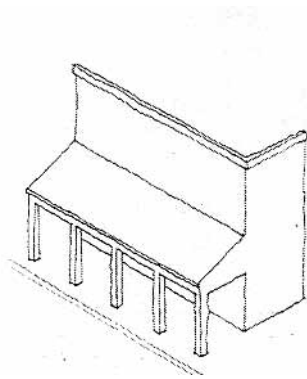

Traditional
Scottsdale walkway.

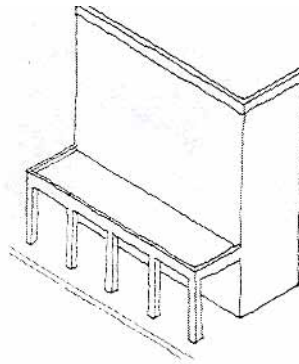

Projected walkway.

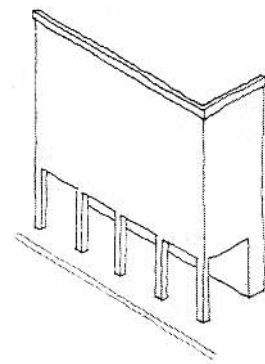

Recessed walkway.

The walkway should be an integral part of each building's architectural character. It should create useful outdoor spaces and provide protection from the sun, not be applied as a superficial or decorative device. The walkway's configuration, dimensions and use may vary with each project, but it should generally be a one story element less than 16 feet high and be defined by columns, arches or other vertical supporting elements.

Specific Guidelines for covered walkways in the Old Town, West Main, Fifth Avenue and Craftsman's Court-Marshall Way Districts are given in Part III "Guidelines for Special Districts".

In type 2 Development Areas where 40 foot building setbacks are required, up to ten feet of the depth of the walkway may be located in the front building setback area.



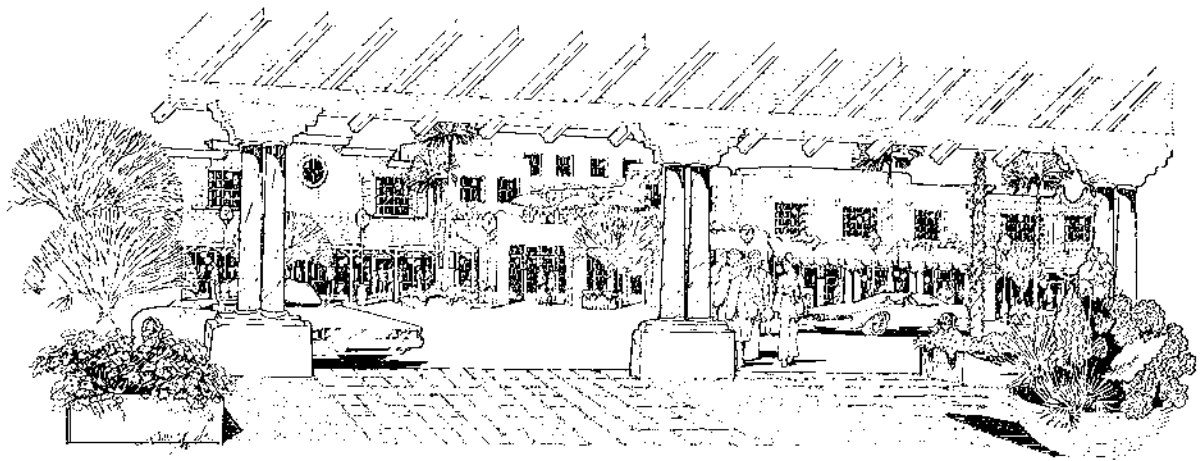

C. ARCHITECTURAL CHARACTER

C1. PROPORTION AND SCALE

-
- Development proposals should demonstrate evidence they have studied the predominant scale and proportions of buildings in the district and street where they are to be located. Elevation sketches, photographic montages and other graphic studies are encouraged.
-

Proportion may be defined as a numerical comparison of parts or as a statement of relative difference between parts (contrast). Scale is the relationship to human size.

PROPORTION SYSTEMS

- Building proportions with horizontal emphasis are generally desired. Avoid vertical proportions that exaggerate building height.
- It is desirable that the spacing of elements in facades be varied rather than repetitive.



Avoid repetitive proportions.



Varied proportions encouraged.

CONTRAST

The relative amount of contrast between building elements is another way of expressing proportion. Designs should observe the following general Guidelines.

- It is desirable that there be a contrast in size of solid area to window area. There should generally be more wall than window.
- Thickness of wall should dominate, and thin elements be used to provide detail.

SCALE

In the Downtown Pedestrian Overlay District, proportions of building elements, especially at the ground level, should be kept intimate and close to human size with relatively small parts. Outside the Pedestrian Overlay District, a mixture of scales may be appropriate, with some elements scaled for appreciation from the street or automobile, and others for appreciation by pedestrians.



C2. BUILDING MATERIALS

- Restraint should be used in the number of different building materials selected. Simplicity of palette is desired.
 - Building materials similar to those in predominant use on the street or in the district of the new project are encouraged.
 - Wall detailing should recess glass surfaces in shadow as deeply as possible within the limits of the selected construction system.
 - Highly reflective materials that create glare should be avoided.
-

Every development proposal should show evidence that the use of building materials in the district and on the street of the new project have been studied. In districts where a particular building material predominates, the new project is encouraged to use the same palette or a similar palette compatible in texture, color and scale with the predominant material. Coordination of materials used on adjacent buildings is desirable when appropriate.

Selection of building materials should give careful consideration to climatic factors, especially the impact of harsh summer sun on western and southern elevations.

Recommended materials and methods of use:

Windows

To reduce solar heat gain and reflection of glare, windows and large areas of glass should be recessed in deep shadow. Glass should be in shadow most of the day from early Spring to late Fall. It is preferable that large glazed areas be divided into smaller parts by using mullions to express individual windows or groupings of windows.

Walls

Expression of wall thickness is desirable. Reveals, returns and deep recesses at openings are encouraged to exaggerate wall thickness.

Unacceptable materials and methods of use:

- Highly reflective, shiny or mirror-like materials that reflect glare into the surrounding environment. These materials may be used only in small areas for architectural details near the ground level.
- Continuous strips or bands of glass without interruption by mullions. The use of flush-mounted glass used in long horizontal patterns should especially be avoided.

C3. COLOR AND TEXTURE

- Building colors should emphasize light and muted colors, with light earth tones dominant.
 - Color selection should show evidence of coordination with the predominant use of color on the street and district of the new project.
-

COLOR

The use of color in Downtown buildings should seek an overall harmony and limited palette. Colors should follow those now in predominant Downtown use: light and muted earth tones for basic surfaces with strong hues and dark colors used only as accents.

The Old Town district has deep and dark earth tones, mostly terra cotta, with white or light accents. This pattern should be continued in Old Town only.

Specific recommendations:

- Ground surface: Warm earth tone colors
- Wall surfaces: Off whites (ivory, Navajo white or other off-white earth tones) or light sun bleached pastels.
- Roofs: Earth tones are preferred.
- Accents: All colors, including intense saturated colors if used in small areas such as courtyards, stairs, doors and windows, ornamental and moulding.

Colors not recommended for Downtown use:

- Highly-reflective colors that cause glare.
- Large dark buildings or surfaces.
- Large areas of dark glass, unless deeply-recessed.
- Colors so dark or intense as to neutralize shadow patterns.
- Saturated hues and bright colors except for use in small areas.

TEXTURE

As a general principle, course and height-textured materials are preferred. Textures in the Southwest are bolder and stronger than in other regions of the country.

Textures not recommended:

- Polished materials, especially that reflect glare
- Surface detail, ornament and other elements that enrich architectural character are encouraged.

C3. ARCHITECTURAL DETAIL

- Surface detail, ornament and other elements that enrich architectural character are encouraged.
-

OUTDOOR STAIRS

Outdoor stairs create rich entry sequences and help make upper stories of a building more visible.

BALCONIES

Balconies provide space for outdoor activity and are often helpful to give scale to a building wall. They provide an element of human size which can effectively contrast with the solid, massive character of a wall.

DETAIL

Cornices, ornamental mouldings, lamps and other details that provide visual interest, shadow, contrast and color are encouraged. This is especially desirable at the pedestrian level. Details should be carefully integrated with the design concept of the building.

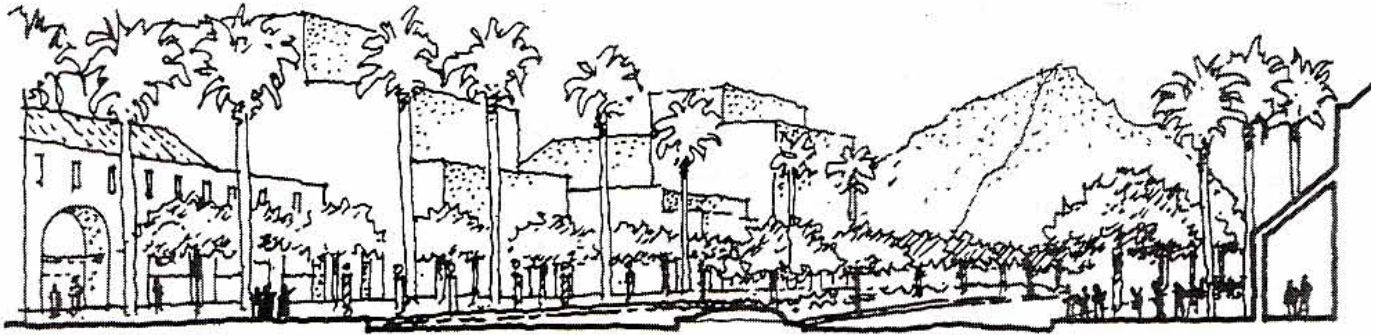

D. LANDSCAPE CHARACTER

D1. STREETS

- Plants, street furniture, paving, and other landscape elements should be organized along streets to create a unified civic appearance. The materials and layout of these elements should conform to City standards.
 - A safe comfortable pedestrian environment should be created as a result of creative street frontage design. Give primary consideration to provision of ample shade, special paving, and buffer between the street and walking space.
-

1. DOWNTOWN STREET TREES

STREET TREES should provide shade, color and varied textures to create a "desert oasis" character along Downtown streets. A combination of theme and accent trees should be selected for appreciation by pedestrians and persons in automobiles.

TREES should be planted in raised planters, geometrically shaped planting beds, or tree wells with grates. Recommendations for species, planting and care are listed in Appendix A: Plant Selection Guide.

THEME TREES generally have the spreading form and in textured foliage characteristic of desert species. They should be spaced to create a regular and rhythmic pattern to provide continuity to the street. When major streets pass through or along a special district, the theme trees for the special district should be used.

ACCENT TREES complement the theme species by providing a contrast of characteristics such as unique form to silhouette against the skyline or building walls, flower or foliage color during different season, or textures which add variety to the landscape. Accent trees can be worked into a structured pattern with the dominant species or used more randomly to relate to site features such as entry drives, sidewalks, courtyards and buildings.

MAJOR STREETS

A tree species has been designed for each major street to establish a monument theme. Additional species have been designated to provide accents or form, color, and texture.



MAJOR STREET

D1. STREETS

Scottsdale Road:

Acacia abyssinica (theme tree) - minimum 1 per 30 feet of street frontage
Dalbergia Sissoo (accent tree) - minimum 1 per 100 feet of street frontage (minimum 1 per site)
Washington robusta (accent) - optional - prefer clusters of 2 or 3

Indian School Road:

Prosopis chilensis (thornless) (theme) - minimum 1 per 30 feet of street frontage
Eucalyptus torquata (accent) - minimum 1 per 60 feet of street frontage
Pistacia atlantica (accent) - minimum 1 per 100 feet of street frontage (minimum 1 per site)

Camelback Road:

Cercidium praecox (theme) - minimum 1 per 30 feet of street frontage
Jacaranda mimosifolia (accent) - minimum 1 per 60 feet of street frontage
Fraxinus velutina "fantex" (accent) - minimum 1 per 100 feet of street frontage (min. 1 per site)

West Couplet:

Prosopis chilensis " inermis" (theme) - minimum 1 per 30 feet of street frontage
Eucalyptus microtheca (accent) - minimum 1 per 60 feet of street frontage
Phoenix dactylifera (accent) - optional - prefer clusters of 2 or 3

East Couplet:

Olea europaea "swan hill" (theme) - minimum 1 per 30 feet of street frontage
Pinus canariensis (accent) - minimum 1 per 100 feet of street frontage
Phoenix dactylifera (accent) - optional - prefer clusters of 2 or 3

Tree plantings along local streets should follow the concept of theme and accent trees using species designated in Appendix A: Plant Selection Guide. At least one tree should be provided for every 30 feet of street frontage.

Street trees to be used along pedestrian-oriented streets in Type 1 Development Areas are designated in Section III: Guidelines for Special Districts.

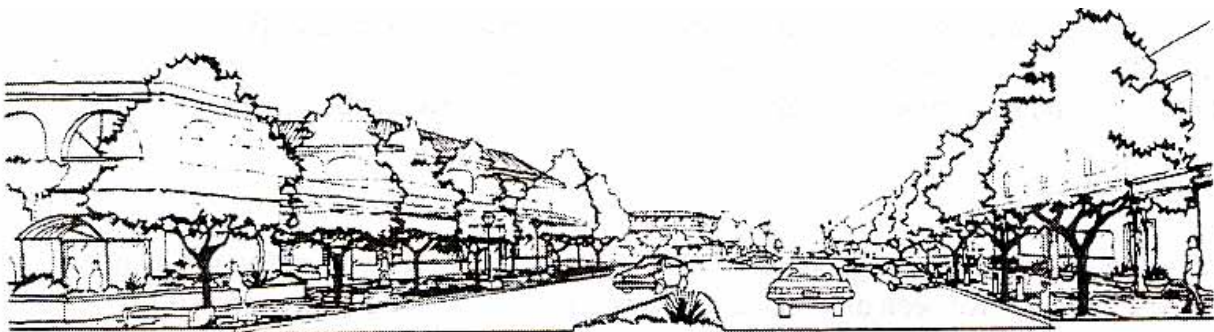

LOCAL STREET

D1. STREETS

2. SETBACK AREA PAVING

The setback area between the street and buildings should be developed as a patio landscape of walkable surfaces (see Guideline A9). All walking areas in Downtown should provide safe and comfortable surfaces and a rich variety of textures, colors, and shapes. Sidewalk treatments which reflect glare or lack visual interest are discouraged. Poured concrete should be textured and/or integrally colored and be enhanced by scoring or accented with other paving materials. The use of brick, tile, pre-cast concrete, and other types of pavers is encouraged.

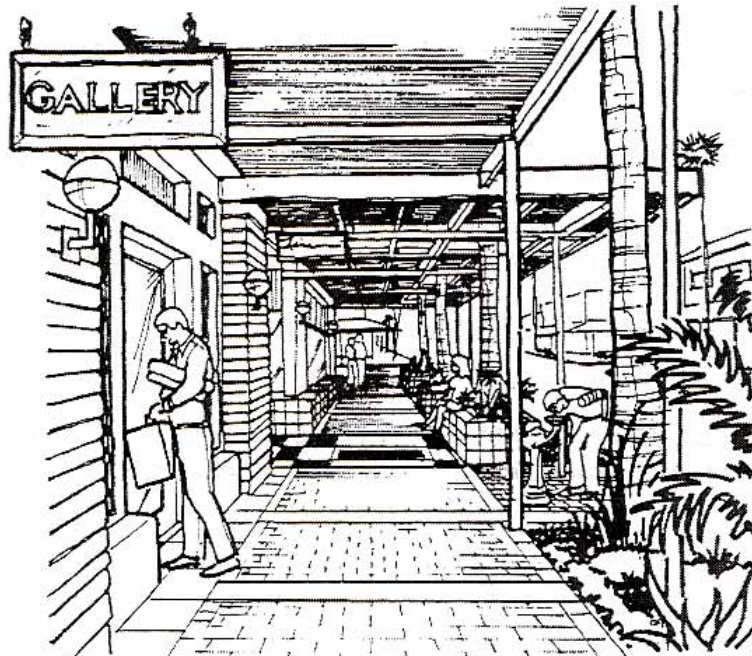

A paving material has been designated for use along each major street. This material should, at a minimum, be used at all street corners, street, alley and drive crossings, and transit stops.

Scottsdale Road - Brick

Indian School Road - Brick

Camelback Road - Pre-cast Concrete Pavers

Couplet - Exposed Aggregate Concrete

Preferred paving treatments for special district are discussed in Section III: Special District Guidelines.

D2. SITE SPACES

- Landscaping for individual sites should provide shade, opportunities to rest, adequate lighting and relief from traffic noise.
 - Design for outdoor spaces should address special site conditions such as solar orientation and relationship to the street, neighboring building and neighboring off-site spaces.
 - Landscape elements should relate closely to the character, materials and function of site architecture.
-

1. Landscape plans for Downtown sites should emphasize places for pedestrian use. Site space which serve no purpose or are inaccessible to pedestrians are discouraged.

Desirable landscape elements include:

- Plant materials which provide shade, color and softening of paved areas
- Seating opportunities such as benches, raised plants, low walls, and sculpture stairs.
- Special features such as fountains and environmental art.
- Pedestrian-scaled lighting

Turfed lawns should be limited to existing residential and institutional development. Lawns are discouraged in new projects except in small, focused areas.

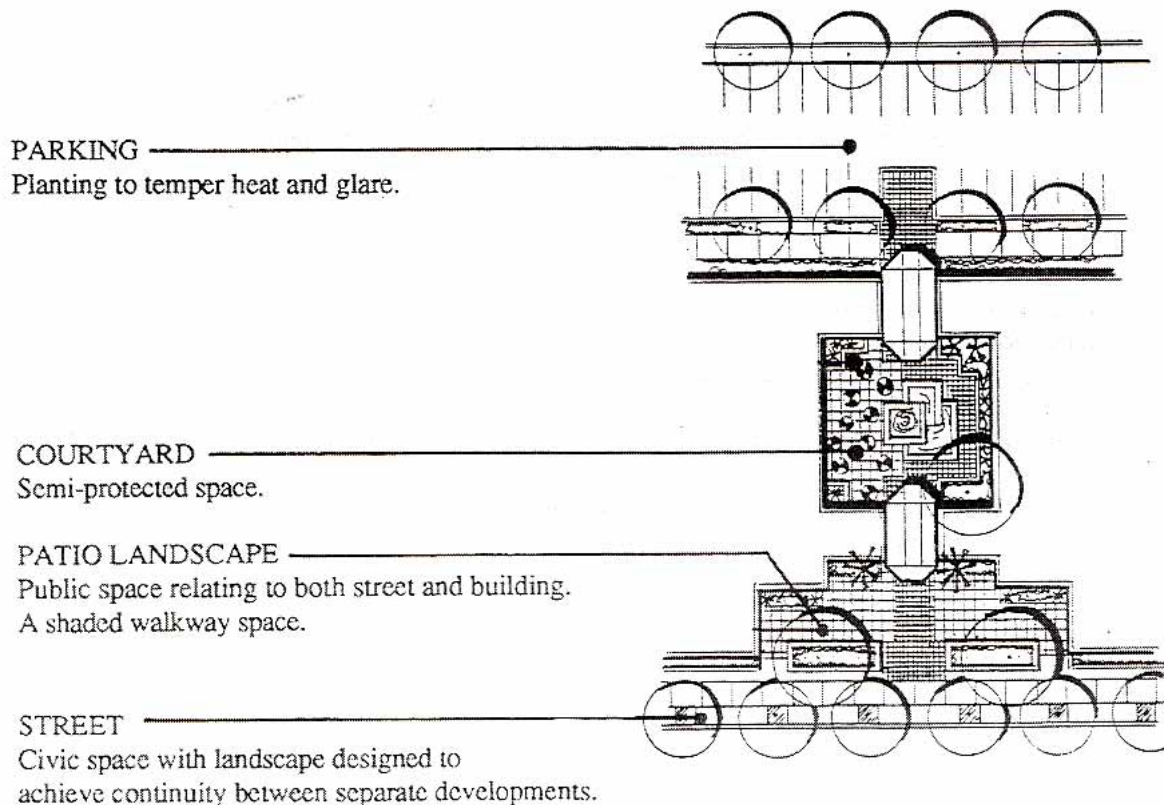

D2. SITE SPACES

2. Following are design considerations for site spaces:

- The PATIO LANDSCAPE should serve as a transition between the public space of the street and private buildings. Patio spaces should accommodate year-round pedestrian use.

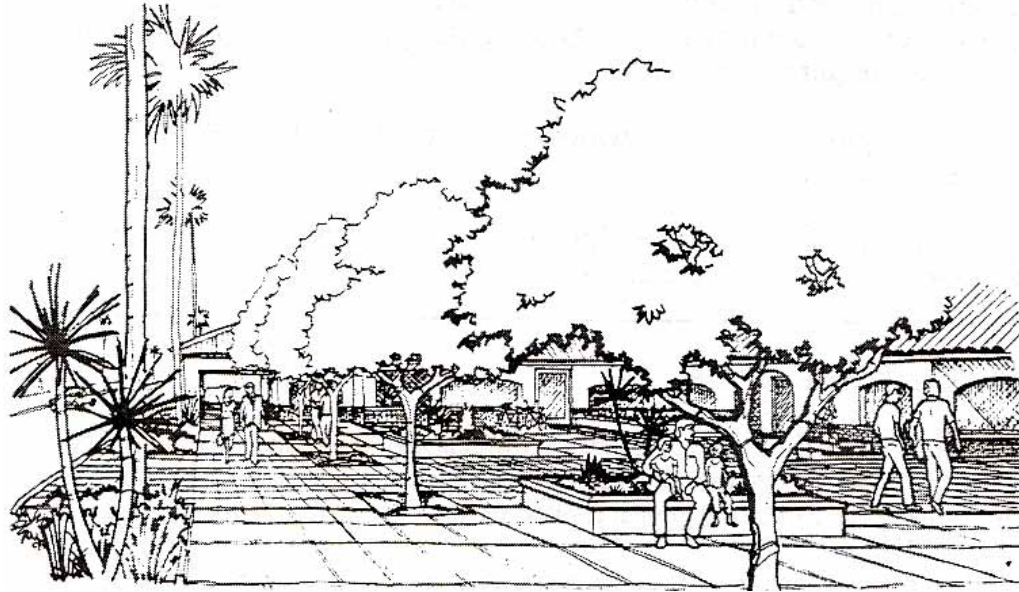

- COURTYARDS are more commonly-located within the site. Buildings define courtyards to provide privacy, protection from the elements and night security. Plant materials which provide festive, colorful, oasis-like courtyard environments are encouraged.
 - SURFACE PARKING LOTS can be unbearable spaces in summer if not properly located and designed. Relief should be provided from direct and reflected sun by regularly-spaced canopy trees and intermittent planting strips. Plant materials should be resilient to difficult growing conditions such as narrow planting space reflected sun and physical abuse.
 - The SOLAR ORIENTATION of outdoor space will greatly affect their use and should be a prime consideration in the placement of landscape elements. Spaces with south or west exposure should be tempered to provide shade and cooling in the summer and to allow sun to penetrate in the winter. Paved areas should be broken up with planting beds to reduce the amount of reflected sun and heat.
3. LANDSCAPE ELEMENTS include plant materials, raised planter beds, planter containers, low seating walls, site furniture, site lighting, fountains and paving materials. The character and plan organization of landscape elements should be consistent throughout a given site.

Landscape elements may be used to:

- delineate pedestrian linkages.
- emphasize entryways and other architectural features
- complement the materials and colors of buildings.

D3. PLANT SELECTION

- The plant palette for individual projects should reinforce Downtown's character as an urban oasis by emphasizing plants that provide shade, year round color and a variety of textures and forms.
- The selection and layout of plant materials should optimize each species' growth potential by recognizing its special environmental and maintenance requirements.
- Planting design for use in downtown projects should respect the need for water conservation.
- A guide is provided for selecting plants compatible with downtown landscape goals. (See Appendix A.)

1. PLANT CHARACTERISTICS

- Most plants have special design characteristics which give them their identity. These characteristics include the color of flowers, leaves, and fruit; size height and spread; the texture of leaves and bark; and growth of habit or form.
- Good planting design creates an attractive composition of colors, textures and forms, and complements the functions and growing conditions of the site.

Large Trees:

- Scale down large buildings
- Provide vertical structure for large plazas and wide streets
- Provide canopies for large plazas and parking lots
- Provide silhouette against the skyline

Medium Trees:

- Provide silhouette against large wall surfaces
- Provide vertical structure for pedestrian spaces
- Provide canopies for sidewalks, plazas and courtyards
- Establish large areas of color above eye level

Small Trees:

- Provide accent color and texture
- Delineate pedestrian linkages and space
- Provide silhouette against lower-level walls

Shrubs:

- Delineate pedestrian linkage and space
- Provide color at and below eye level
- Screen unsightly views

Groundcover & Vines:

- Provide a variety of color and texture
- Break up flat surfaces
- Control erosion

Succulents, Annuals and Others:

- Provide special effects, character, theme, and accent
- Promote Scottsdale's established resort lifestyle
- Create a downtown urban oasis experience

D3. PLANT SELECTION

2. SPECIAL ENVIRONMENTAL AND MAINTENANCE REQUIREMENTS

The compact, urban nature of Downtown sites present special problems of physical abuse, tight planting spaces, compacted soil, reflected sun and drainage. Matching plants which satisfy the desired visual character with the function and growing conditions of various outdoor spaces is a complex process. It is critical for the designer to fully understand:

- the environmental conditions of the low desert
- the specific site conditions
- the environmental and maintenance requirements of plant species available for Downtown use.

Following are considerations which must be made in the plant selection process for Downtown projects.

Water:

- Plants requiring ample amounts of water to maintain a healthy appearance should be used only in confined and easily-monitored areas
- The Arizona Department of Water Resources requires the species selected for use in the public right-of-way be on the "Low Water Using Plant List" for the Phoenix Active Management Area.

Sun:

- Some plants require full sun to attain their best appearance, especially flowering species. These plants do best with south or west exposures.
- Protection for plants which cannot withstand full sun exposure can be provided by having a north or east exposure, or shade from larger plants.
- Reflected sun is a problem for some plants and can be tempered by larger planting spaces shielded by heat-tolerant plants along south and west edges.

Negative Characteristics:

Plants which produce excessive thorns, pollen, fruit or brittle wood are discouraged.

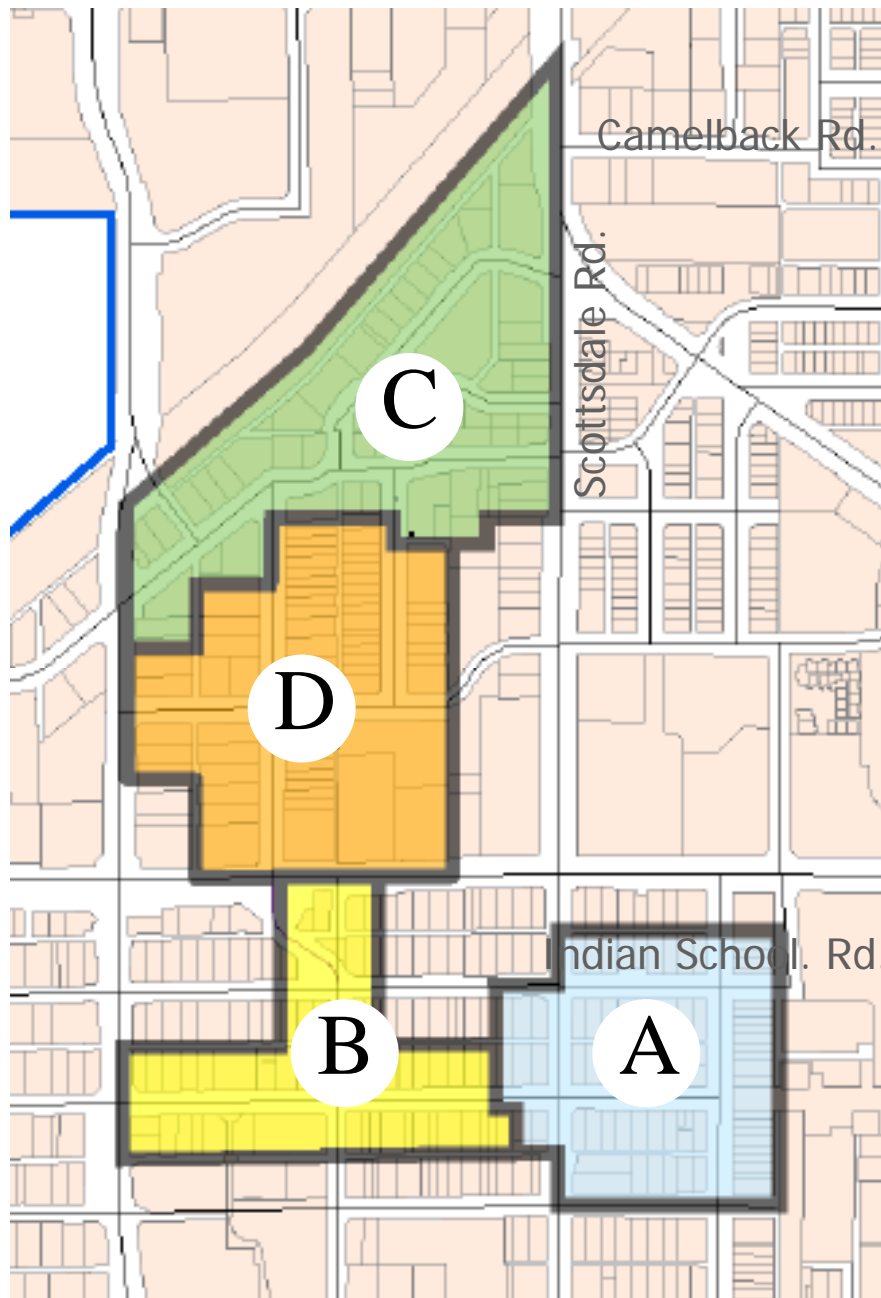

SPECIAL DISTRICTS

- A. OLD TOWN
- B. MAIN STREET
- C. FIFTH AVENUE
- D. MARSHALL WAY-CRAFTSMAN'S COURT

III. GUIDELINES FOR SPECIAL DISTRICTS

GUIDELINES FOR SPECIAL DISTRICTS

Downtown's older districts are an important part of Scottsdale's history and an attraction to both residents and visitors. New development must respect the existing scale and character of neighboring buildings and must contribute to the urban design goals of its district location.

This section presents Design Guidelines for Downtown Special Districts:

- A. Old Town
- B. Main Street
- C. Fifth Avenue
- D. Marshall Way-Craftsman's Court
- E. The Couplet

In cases where the Special District Guidelines listed in this section differ from or are more specific than the General Downtown Guidelines of Section II, these Special District Guidelines shall apply. Otherwise, all provisions of the General Guidelines should be followed.

The discussion of each district is introduced by a summary of the district's urban design objectives, followed by a listing of specific Design Guidelines. The Design Guidelines are organized in the following categories:

DESIRABLE CHARACTERISTICS which reinforce or are compatible with district design objectives.

UNACCEPTABLE CHARACTERISTICS which are incompatible with district design objectives and unlikely to be approved in Development Review.

A. OLD TOWN



Old Town is a key element of Scottsdale's reputation as "the West most Western Town." Its history and identity as a specialty shopping district for Western goods, Indian jewelry and crafts, and Southwestern artifacts is to be preserved by strong measures to protect and strengthen its frontier town character.



OLD TOWN DESIGN DISTRICT

A. OLD TOWN

URBAN DESIGN OBJECTIVES

1. Maintain the frontier town "Western" image of Old Town
2. Preserve the present fine-grain pattern, pedestrian scale, and active building frontages that are essential to Old Town's success as a specialty shopping district.
3. Emphasize the covered walkway system as a unifying element on Old Town streets.
 - Require covered walkways on all building frontages.
 - Follow Design Guidelines for coordinating basic covered walkway form, dimensions and materials.
4. Reinforce the frontier image of Old Town's architecture with carefully-placed landscaping of an arid character.

DESIGN GUIDELINES

Design Guidelines for new construction and remodeling apply to the area defined on the Old Town Design District map. The Guidelines are presented in the tables on the following pages.

DESIRABLE	CONDITIONALLY ACCEPTABLE	UNACCEPTABLE
BUILDING FORM		
<p>Width: Apparent building & storefront width maximum 50 feet</p>		<p>Parapets or continuous elevation plans over 75 feet long. Apparent storefront widths over 50 feet</p>
<p>Entrances: Provide at least one storefront entrance for every 30 feet of building width</p>	<p>One storefront entrance for every 50 feet of building width.</p>	
<p>Roof Form: Gable. Flat roof with false front or parapet.</p>		<p>Hip roofs.</p>
BUILDING WALLS		
<p>Storefronts: A minimum of 2/3 of lower story frontage should contain clear glass openings with views into shops.</p>		
<p>Storefront windows: wood frame set in solid wall with raised sill at least 3 feet above first floor level. Stained or painted finish. Clear glass.</p>	<p>Metal, if dark color and flat finish.</p>	
<p>Storefront doors: Same material as windows.</p>	<p>Same material as windows.</p>	
<p>Wall materials: Wood siding - Board and batten, lap, shipland, tongue and groove. Vertical or horizontal. Finish: Opaque or semitransparent earth tone colors with light accent option. Flat finish. Stucco, stone or brick may be used below sill height. Preferred color for stucco is light earth tone.</p>	<p>Stucco, mortar-washed concrete or slump block, adobe or burned adobe block, common or irregular-shaped brick. Wood with log pattern.</p>	<p>Plywood, unless accompanied by battens. Shiny metal, polished surfaces, clear aluminum and high- gloss surfaces. Glass curtain walls. Unfinished slump block, wire-cut and unvarigated brick</p>
SIGNS		
<p>Above Covered Walkways Roof: Flat to wall. Painted or low profile cutout letters. Bold-stroke seriphed letters preferred, with letter contrast 40-70%. Indirect illumination with shielded light source</p>		
<p>Under the Covered Walkway: Wood hanging signs. Maximum area 2 sq. ft. each face. Minimum head clearance 7-6". Bold stroke painted signs may be used on windows.</p>		

OLD TOWN

DESIRABLE

COVERED WALKWAYS

Roof form:

Shed roof supported by post and beam structure. Pitch range between 3:12 and 5:12

Roof materials:

Wood shingle or shake.

Supports:

Wood columns with square, rectangular or round cross section. Maximum dimension or diameter 12 inches.

Maximum cross sectional area 1 sq. ft.

Spacing minimum 10 feet on center, maximum 15 feet on center.

Paving:

Textured concrete with wood board pattern or broom finish; Bomanite.

Color tint with earth tone. Brick or tile, if non-slip surface.

CONDITIONALLY ACCEPTABLE

Clay tile lightweight random style composition shingle.

Brick Maximum cross sectional area 1 sq. ft.

UNACCEPTABLE

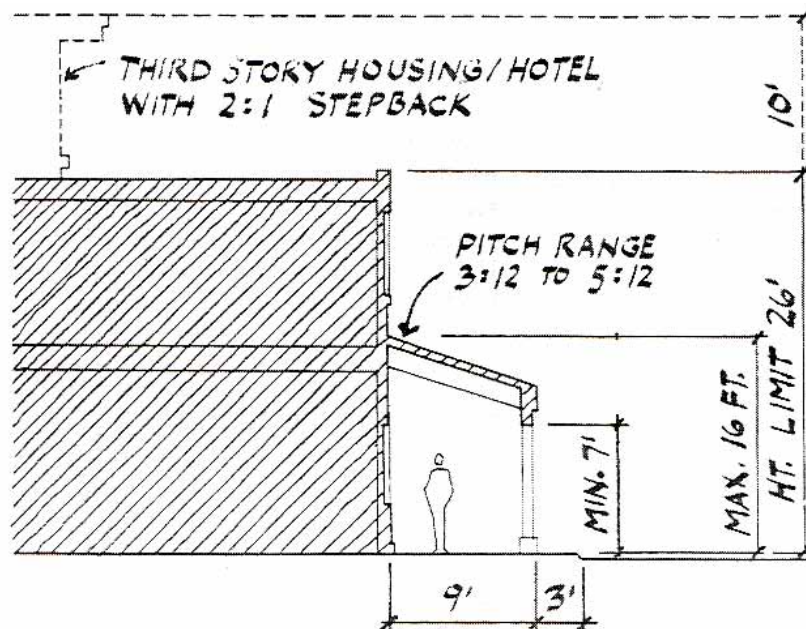

OLD TOWN

DESI RABLE

LIGHTING

Exterior decorative lighting should be of western theme. Incandescent or halide lamps preferred.

DETAILS

Hitching posts, benches, lamp posts, earthen pots, watering tanks, swinging doors and other "Western" details encouraged.

**CONDITIONALLY
ACCEPTABLE**

Wrought iron window guards, gates and signs. Wood planter boxes, wood shutters.

UNACCEPTABLE

Unshielded spot or flood lighting

Details incompatible with the district's historic "Western" character. Plastic, fiberglass, shiny metal details.

PLANT MATERIALS

Street trees:

Sweet Acacia, Mesquite, Palo Brea

Location: Street corners, courtyards, parking lots.

B. WEST MAIN



The "West Main" district focuses on the street frontage of Main Street from Scottsdale Road west to 70th Street, and Marshall Way from Main Street north to Indian School.

As one of Scottsdale's most attractive gallery districts, West Main benefits from a continuity of character based on its pedestrian scale, covered walkways, individual shops and distinctive palm planting along Main Street.



MAIN STREET DESIGN DISTRICT

B. WEST MAIN

URBAN DESIGN OBJECTIVES

1. Preserve and strengthen West Main's gallery character and fine-grain building pattern.
2. Create a pedestrian connection with the Fifth Avenue and Marshall Way Districts to the north.
 - Develop pedestrian improvements and a strong, consistent street tree planting pattern along Marshall Way to emphasize its importance as a linkage
 - Use Marshall Way as a Trolley route
3. Take advantage of the Couplet to improve West Main's visibility and access.
 - Provide new public parking with clear and convenient access from the Couplet.
 - Provide design "gateways" marking the entrance to West Main from the Couplet.
4. Improve the continuity of West Main's building frontages while maintaining the present diversity or architectural character.
 - Require covered walkways on all Main Street building frontages between Scottsdale Road and Goldwater Boulevard, and on Marshall Way between Main Street and Indian School Road.
 - Follow the Design Guidelines for walkway dimensions, forms and setbacks
 - Use a limited range of building materials consistent with the district's present character.
5. Develop a strong, consistent street tree program to help unify the district's street character.
 - Continue the present pattern of palms along Main Street and add them to Marshall Way.
 - Require street tree planting in new developments, and encourage similar plantings on existing building frontages.

DESIGN GUIDELINES

Design Guidelines for new construction and remodeling apply to the area defined on the West Main Design District map. The Guidelines are presented in the table on the following pages.



WEST MAIN

ARCHITECTURE AND LANDSCAPE CHARACTERISTICS

DESIRABLE

CONDITIONALLY ACCEPTABLE

UNACCEPTABLE

BUILDING FORM

Apparent building and storefront width maximum 50 feet

Apparent building width 75 feet

Parapets or continuous front elevation planes over 75 feet. Apparent storefront widths over 50 feet.

BUILDING ENTRANCES

Provide at least one storefront entrance for every 30 feet of building width.

One storefront entrance for every 50 feet of building width

BUILDING WALLS

Storefronts:

A minimum of 2/3 of lower story frontage should contain clear glass openings with views into shops

Storefront windows and doors: Clear glass set in wood frame. Stained or painted finish (light colors preferred).

Metal, if matte finish

Shiny metal, clear-finished aluminum

Wall materials:

Wood siding, stucco, mortar-washed concrete or slump block, adobe or burned block, brick. Colors: light tones

Plywood, shiny materials, polished materials, glass curtain walls.

SIGNS

Wall signs with indirect illumination from shielded light source

Hanging signs under the covered walkway. Maximum area 2 sq. ft. each face. Minimum 7'-6" head clearance.

Internally-illuminated box or plastic signs. Fluorescent or neon tubing.

LIGHTING

All exterior light sources and interior light sources visible from the street or sidewalk must have lamps shielded from view. Incandescent or halide lamps preferred.

Unshielded spot or flood lighting.

SITE DETAILS

Street furniture such as wood benches, courtyard fountains, planter boxes, earthen pots and pedestrian-scale lighting encouraged

Plastic, fiberglass, plywood, shiny metals.

MAIN STREET

DESIRABLE

CONDITIONALLY ACCEPTABLE

UNACCEPTABLE

COVERED WALKWAYS

Roof form:

Flat roof with parapet. Shed roof of 3:12 to 5:12 pitch.

Roof materials:

Wood shingle or shake, clay tile or metal with standing seam or batten.

Random style composition shingle.

Supports:

Columns - square, rectangular or round.

Maximum dimension or diameter 2 inches.

Maximum cross sectional area 1 sq. ft.

Spacing minimum 10 feet, maximum 15 feet, on center.

Arches - minimum 10 feet, maximum 15 feet on center. Maximum cross sectional at base 2 sq. ft.

Support materials:

All materials listed for wall materials.

Paving:

Textured concrete. Light earth tone color tint. Brick or tile, if non-slip surface. A flush grate or other flush surface should be used around trees.

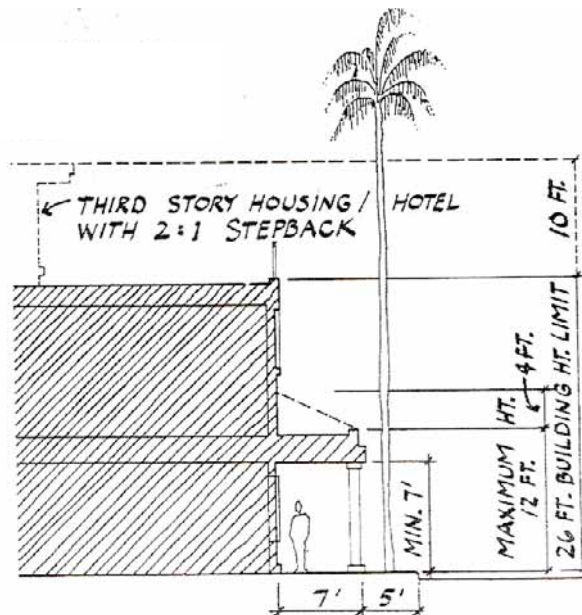

Covered walkway maximum height:

- 12 feet with flat roof
- 16 feet with shed roof

MAIN STREET

PLANT MATERIALS

Street Trees:

Mexican Fan Palm, Australian Willow. Provide Mexican Fan Palm trees at a 25 foot interval for cadence and accent along the street. Provide the Australian Willow (for shade) in a more varied pattern.

Location:

Between Covered Walkways and curb, courtyards, parking lots and street corners.

C. FIFTH AVENUE



The Fifth Avenue district contains dining and specialty shops of Fifth and Sixth Avenues, and Stetson Drive. Like Old Town and West Main, Fifth Avenue's pedestrian orientation and consistent character provide a strong attraction to shoppers and visitors.

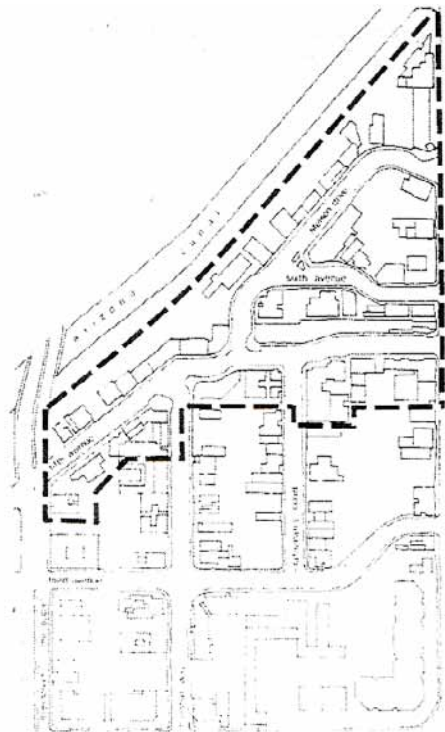

FIFTH AVENUE DESIGN DISTRICT

C. FIFTH AVENUE

URBAN DESIGN OBJECTIVES

1. Strengthen Fifth Avenue's specialty shopping environment by maintaining active street frontages with continuous shops and frequent building entrances.
2. Create a pedestrian and Trolley connection to the West Main district along Marshall Way.
3. Take advantage of the Couplet.
 - Provide new public parking with clear and convenient access to the Couplet
 - Provide designed "gateways" at the Fifth Avenue Couplet entrance.
4. Improve the potential of the Arizona Canal frontage as a walking promenade with shops, restaurants and other activities carefully linked to Fifth Avenue.
5. Improve the character and continuity of the district's street spaces.
 - Require covered walkways on all new buildings on Fifth Avenue, Sixth Avenue and Stetson Drive. Encourage them on all other building frontages in the district.
 - Provide street tree plantings in new development and encourage similar planting on existing building frontages.

DESIGN GUIDELINES

Design Guidelines for Fifth Avenue apply to new construction and remodeling in the area defined on the Fifth Avenue Design map. The Guidelines are presented in the table on the following pages.



FIFTH AVENUE

ARCHITECTURE AND LANDSCAPE CHARACTERISTICS

DESIRABLE

STOREFRONT WIDTH

Apparent storefront width maximum 50 feet.

BUILDING ENTRANCES

Provide at least one storefront entrance for every 30 feet of building width.

BUILDING WALLS

Storefronts:

A minimum of 2/3 of lower story frontage should contain clear glass opening with views into shops.

Storefront windows and doors: Clear glass set in wood frame. Stained or painted finish (light colors preferred).

Wall materials:

Wood siding, stucco, mortar-washed concrete or slump block, adobe or burned block, brick. Colors: light earth tones. Vivid colors may be used as accents in small areas.

SIGNS

Wall signs with indirect illumination from shielded light source.

LIGHTING

All exterior light sources and interior light sources visible from the street or sidewalk must have lamps shielded from view. Incandescent or halide lamps preferred.

SITE DETAILS

Street furniture such as wood benches, courtyard fountains, planter boxes, earthen pots and pedestrian lighting are encouraged.

CONDITIONALLY ACCEPTABLE

One storefront entrance for every 50 feet of building width.

Metal, if matte finish and light color.

Pastel colors.

Hanging signs under the covered walkway. Maximum area 2 sq. ft. each face. Minimum 7'-6" head clearance.

Decomposed granite. Fiberglass plant containers.

UNACCEPTABLE

Apparent storefront widths over 50 feet.

Shiny metal, clear-finish aluminum.

Plywood, shiny materials, polished materials, glass curtain walls.

Internally-illuminated box plastic signs. Fluorescent or neon tubing.

Unshielded spot or flood lighting.

Plastic, plywood, shiny metals.

FIFTH AVENUE

DESIRABLE

CONDITIONALLY ACCEPTABLE

UNACCEPTABLE

COVERED WALKWAYS

Roof form:

Flat roof with parapet. Shed roof
of 3:12 to 5:12 pitch

Roof materials:

Clay tile

Metal with standing seam or

batten

Supports:

Columns - square, rectangular or
round. Maximum dimension or
diameter 12 inches. Maximum cross
sectional area 1 sq. ft. Spacing
minimum 10 feet of center,
maximum 15 feet on center.
Maximum cross sectional at base 2
sq. ft.

Support materials:

All materials listed for wall
materials.

Paving:

Textured concrete. Light earth
tone color tint. Brick or tile, if non-
slip surface.

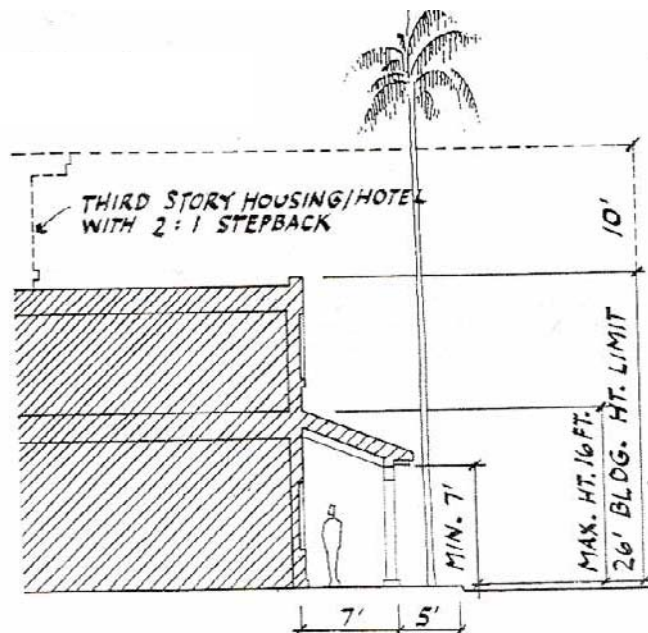

Covered walkway maximum height:

- 12 feet with flat roof
- 16 feet with shed roof

FIFTH AVENUE

DESIRABLE

**CONDITIONALLY
ACCEPTABLE**

UNACCEPTABLE

PLANT MATERIALS

Street Trees:
Jacaranda.

Location:
Between Covered Walkway and
curb, courtyards and street
corners.

D. MARSHALL WAY- CRAFTMAN'S COURT

The Marshall Way reputation as a focus for galleries and art-oriented shops make it a key regional attraction and important asset in Downtown's mix of activities.

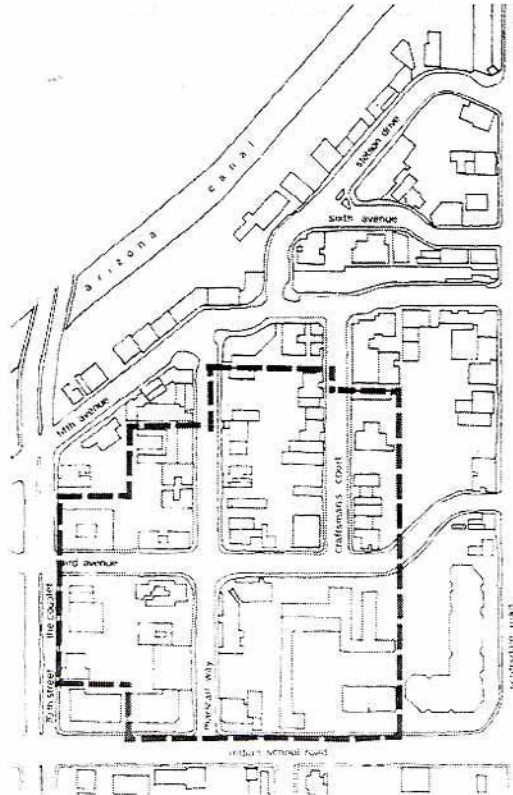

MARSHALL WAY - CRAFTMAN'S COURT DESIGN DISTRICT

D. MARSHALL WAY- CRAFTMAN'S COURT

URBAN DESIGN OBJECTIVES

1. Promote Marshall Way's identity as an arts and gallery district.
 - Public art and sculpture are encouraged along building fronts, in courtyards and at other visible areas of new projects.
2. Strengthen the role of Marshall Way as an important pedestrian link between West Main and Fifth Avenue.
 - Maintain fine-grain building character, active street frontages and continuous pedestrian interest.
 - Reinforce Marshall Way's pedestrian emphasis by using it as a Trolley route
 - Require covered walkways on all building frontages
3. Improve the variety of pedestrian choices by encouraging courtyards in new developments. The frequency of building courtyards is a special feature of the district that should be continued and strengthened.
4. Address the Couplet by providing clear access to public parking and "gateways" marking entrances to the district.
5. Improve street character through an ambitious street landscape program. Provide landscaped "patio" space and street tree plantings in new development. Encourage their provision along existing building frontages.

DESIGN GUIDELINES

Design Guidelines for Marshall Way apply to new construction and remodeling in the area defined on the district map. The Guidelines are presented in the table on the following pages.

**MARSHALL WAY -
CRAFTSMAN'S COURT**

ARCHITECTURE AND LANDSCAPE CHARACTERISTICS

DESIRABLE

STOREFRONT WIDTH

Apparent storefront width maximum 50 feet.

CONDITIONALLY ACCEPTABLE

UNACCEPTABLE

Apparent storefront widths over 50 feet

BUILDING ENTRANCES

Provide at least one storefront entrance for every 30 feet of building width

One storefront entrance for every 50 feet of building width.

BUILDING WALLS

Storefronts:

A minimum of 2/3 of lower story frontage should contain clear glass opening with views into shops.

Storefront windows and doors:

Clear glass set in wood frame.

Stained or painted finish (light colors preferred). Metal, if matte finish and light color.

Shiny metal, clear-finished aluminum

Wall materials:

wood siding, stucco, mortar-washed concrete or slump block, adobe or burned block, brick.

Colors: light earth tones. Vivid colors may be used as accents in small areas.

Pastel colors.

Plywood, shiny materials, polished materials, glass curtain walls.

SIGNS

Wall signs with indirect illumination from shielded light source.

Hanging signs under the covered walkway. Maximum area 2 sq. ft. each face. Minimum 7'-6" head clearance.

Internally-illuminated box or plastic signs. Fluorescent or neon tubing.

LIGHTING

All exterior light sources and interior light sources visible from the street or sidewalk must have lamps shielded from view.

Incandescent or halide lamps preferred.

Unshielded spot or flood lighting.

SITE DETAILS

Street furniture such as wood benches, courtyards fountains, planter boxes earthen pots and pedestrian lighting are encouraged.

Decomposed granite. Fiberglass plant containers.

Plastic, plywood, shiny metals.

MARSHALL WAY - CRAFTSMAN'S COURT

DESIRABLE

COVERED WALKWAYS

Roof form:

Flat roof with parapet. Shed roof of 3:12 to 5:12 pitch

Roof materials
Clay tile.

Supports:

Columns - square, rectangular or round. Maximum dimension or diameter 12 inches.

Maximum cross sectional area 1 sq. ft. Spacing minimum 10 feet of center, maximum 15 feet on center. Arches - spacing minimum 10 feet, maximum 15 feet on center. Maximum cross sectional at base 2 sq. ft.

Support materials:

All materials listed for wall materials.

Paving:

Textures concrete. Light earth tone color tint. Brick or tile, if non-slip surface.

CONDITIONALLY ACCEPTABLE

UNACCEPTABLE

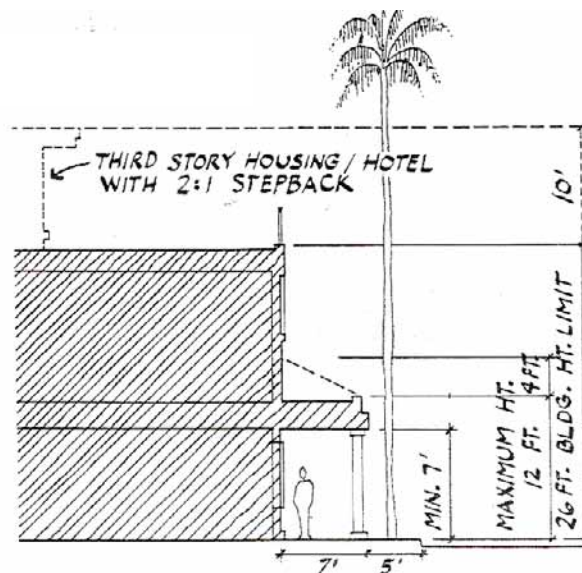

Covered walkway maximum height:

- 12 feet with flat roof
- 16 feet with shed roof

MARSHALL WAY - CRAFTSMAN'S COURT

DESIRABLE

CONDITIONALLY ACCEPTABLE

UNACCEPTABLE

PLANT MATERIALS

Street Trees:

Mexican Fan Palm, Eucalyptus

Torquata.

Location:

Between Covered Walkway and
curb, courtyards and street
corners.

E. THE COUPLET

URBAN DESIGN OBJECTIVES

1. Develop a strong "civic" image by treating the Couplet as Scottsdale's most important public boulevards.
 - Combine a distinctive public landscape program for the right-of-way with specific Landscape Guidelines to unify the front setback spaces of private developments.
 - Develop a coordinated, thematic street signage and graphics system.
 - Follow the Couplet Design Guidelines to improve architectural continuity of new buildings.
2. Mark entry points to Downtown and the individual Downtown districts through designed "gateways" and special landscape elements.
3. Feature views of Camelback Mountain from the Couplet, especially the views created at the diagonal alignments.

DESIGN GUIDELINES

Following are Design Guidelines for new development projects with frontage on the Couplet.

1. Minimum Front Building Setback (required by Zoning Ordinance):
 - Type 1 areas: 12 feet from planned curb
 - Type 2 areas: 30 feet from planned curb.
2. Building Lines
 - Carefully follow the provisions of Guideline A8 "The Continuity of Street Spaces".
3. Building Orientation
 - Buildings on the Couplet should orient their primary elevations toward the Couplet frontage. Avoid blank walls, service areas and other elements that reduce the importance of the Couplet frontage.
4. Parking Location.
 - Avoid locating parking areas along the Couplet frontage. Strive to locate all parking to the rear of buildings, minimizing its visibility from the street.
5. Building Base.
 - As a unifying urban design element, provide a covered circulation element or other form of shaded base along the Couplet frontage. Follow the provisions of Guideline B2 "Covered Walkways".
6. The Building Setback Zone.

Develop the space between the building and street as a patio landscape, carefully following Guideline A9 "The Building Setback Zone"
7. Landscape Character

Establish visual structure and continuity with regular planting of street trees.

E. THE COUPLET

Recommended street trees:

West Couplet - Goldwater Boulevard:

Prosopis chilensis "inermis" (theme) - minimum 1 per 30 feet of street frontage

Eucalyptus microtheca (accent) - minimum 1 per 60 feet of street frontage

Phoenix dactylifera (accent) - optional - prefer clusters of 2 or 3

East Couplet - Drinkwater Boulevard:

Olea europaea "swan hill" (theme) - minimum 1 per 30 feet of street frontage

Pinus canariensis (accent) - minimum 1 per 100 feet of street frontage

Phoenix dactylifera (accent) - optional - prefer clusters of 2 or 3

8. Views of Camelback Mountain

- Consider views of the mountain from the couplet and attempt to preserve and frame them in the siting of new buildings.
- Avoid pedestrian bridges and other built obstructions that block views of the mountain from the couplet. When bridges occur, they should be transparent and delicate in character, not wall-like and opaque.

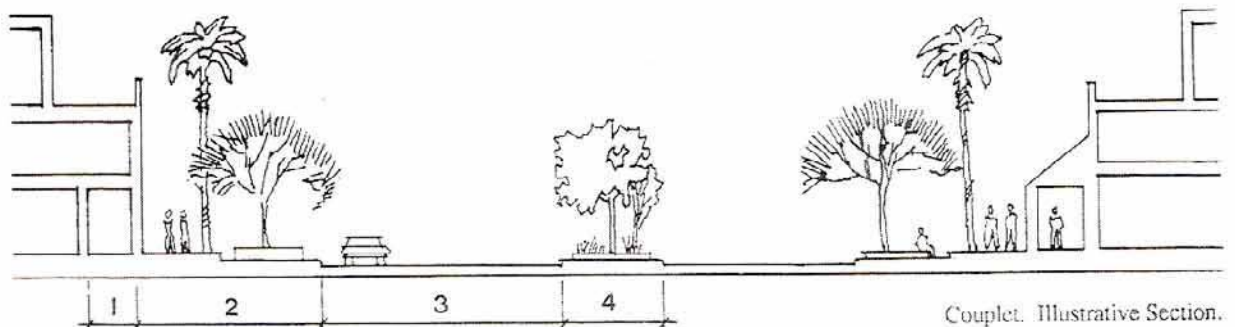

1. Covered walkway
2. Setback zone with "patio" landscape
3. Roadway
4. Landscape Median

APPENDIX A

Plant Selection Guide

1. The following **Plant Selection Guide** is to be used for projects subject to Development Review. The plants on this list are those which are most compatible with the high activity, pedestrian oriented environment of downtown. The guide lists uses for which these plants are best suited and the conditions and maintenance levels which produce the best appearance.

The Development Review Board will consider other plant species which are proven to be compatible with downtown Scottsdale's landscape, urban design objectives, climate and growing conditions.

2. **USE:**

Listed are outdoor spaces for which it is recommended plants be used. These spaces are defined as:

- **Major Streets** - Camelback Road, Scottsdale Road, Indian School Road, the Couplet. Forty (40) foot planned setbacks.
- **Local Streets** - Streets with 12 foot planned setbacks
- **Patio/Plazas** - Transition areas between the street and buildings
- **Courtyards** - Outdoor space defined and semi-protected by architectural elements such as walls.
- **Parking Lots** - Surface parking areas
- **Entryways** - Building entrances or atriums
- **Balconies** - Outdoor space located above lower level uses.

3. **CULTURAL/MAINTENANCE REQUIREMENTS**

Listed are special cultural and maintenance requirements which must be addressed so plants can achieve their optimal potential for growth, attractiveness, and safety.

4. **Special Districts**

Plants indicated in these columns are those recommended to provide continuity along street frontage in each specific district. Other plant materials can be used in addition to these.

APPENDIX A

Street Tree Planting Guidelines

1. To allow adequate aeration of street tree roots, approximately 25% of a development's frontage soil should be opened to the air. This should be accomplished through raised planters, geometrically shaped planting beds or tree wells.
2. The use of planting troughs which allow planting of multiple trees and provide adequate room for root growth is encouraged. (See figure A-1)
3. Street trees should be sized at 36" box when installed. In cases where it is proven that the recommended species is not available in 36" box, the minimum installation size will be 24" box. Palm trees should be at least 15' tall as measured from ground to base of fronds.
4. Planting pits should be twice the width and depth of a tree's root ball. Minimum pit sizes and opening for various tree sizes are:

Small trees:	3' deep x 3' wide	- 3' open air basin
Medium trees:	4' deep x 5' wide	- 4' open air basin
Large trees:	6' deep x 6' wide	- 6' open air basin

A drainage chimney should be established if there is indication of poor sub-soil drainage.

5. To reinforce the pedestrian character desired along downtown streets, street trees must be appropriately maintained. Special care should be provided in pruning-up trees. It is essential to provide adequate clearance for pedestrians while maintaining the sculptural character of the tree's trunk and branches.
6. Tree canopies should not extend into the path of oncoming street traffic. Placing trees an adequate distance behind the curb and/or selective pruning of lower branches will prevent conflicts between plants and traffic.
7. Street trees and undercover plantings which share ground space should have compatible water requirements.

*Trees are categorized in the Plant Selection Guide by their size at maturity.



Appendix 8-1A

RECOMMENDED PLANTS FOR DOWNTOWN

*Plants listed on Arizona Department of Water Resources lists of native, drought tolerant and low water-use plants, trees and shrubs.									
BOTANICAL NAME	LOW WATER USE*	COMMON NAME	MAJOR STREET	LOCAL STREET	PEDESTRIAN STREET	PATIO / PLAZA	COURTYARD	PARKING LOT	ENTRYWAY
OLD TOWN									
GROUNDCOVERS, VINES & OTHER									
<i>Agave murpheyi</i>	✓	Murphy's Agave		●	●	●			
<i>Aloe</i>	✓	Blue Elf		●	●	●	●		
<i>Aloe mawei</i>	✓	Dawe's Aloe		●	●	●	●		
<i>Antigonon leptopus</i>	✓	Coral Vine/Queen's Wreath				●	●		
<i>Baileya multiradiata</i>	✓	Desert Marigold	●	●	●			●	
<i>Cereus hildemannianus</i>	✓	Night Blooming Cereus	●	●	●				
<i>Dyssodia pentachaeta</i>		Golden Fleece		●	●	●	●	●	
<i>Hymenoxys acaulis</i>		Anjelita Daisy		●	●	●	●	●	●
<i>Lantana montevidensis</i>	✓	Trailing Lantana	●	●	●	●	●	●	
<i>Podranea ricasoliana</i>	✓	Pink Trumpet Vine				●	●		
<i>Stenocereus thurberi</i>	✓	Organ Pipe Cactus	●	●	●				
<i>Yucca aloifolia</i>	✓	Spanish Bayonet			●	●	●		
<i>Yucca baccata</i>	✓	Banana Yucca	●	●				●	
SHRUBS									
<i>Encelia farinosa</i>	✓	Brittlebush	●	●	●			●	
<i>Guaiacum coulteri</i>	✓	Guayacan	●	●	●	●		●	
<i>Lantana camara</i>	✓	Lantana, Shrub Verbena	●	●	●	●	●	●	
<i>Leucophyllum frutescens</i>	✓	Texas Sage	●	●	●				
<i>Maytenus phyllanthoides</i>	✓	Mangle Dulce	●	●	●			●	
<i>Muhlenbergia rigens</i>		Deer Grass		●	●			●	
<i>Salvia clevelandii</i>	✓	Cleveland Sage	●	●	●			●	
<i>Simmondsia chinensis</i>	✓	Jojoba	●	●	●	●		●	
<i>Tecoma stans</i>	✓	Yellow Bells		●	●	●	●		
SMALL TREES									
<i>Acacia willardiana</i>	✓	Palo Blanco			●	●	●		
<i>Bauhinia blakeana</i>		Orchid Tree				●	●		
<i>Caesalpinia mexicana</i>	✓	Mexican Bird Of Paradise		●	●	●	●		
<i>Caesalpinia platyloba</i>	✓	Palo Colorado		●	●	●	●		
<i>Chamaerops humilis</i>	✓	Med. Fan Palm				●	●		
<i>Eucalyptus erythrocorys</i>	✓	Red Cap Gum		●	●	●			
<i>Lysiloma thornberi</i>	✓	Fern Of The Desert		●	●	●		●	
<i>Sophora secundiflora</i>	✓	Texas Mountain Laurel		●	●	●	●		



Appendix 8-1A

RECOMMENDED PLANTS FOR DOWNTOWN

*Plants listed on Arizona Department of Water Resources lists of native, drought tolerant and low water-use plants, trees and shrubs.									
BOTANICAL NAME	LOW WATER USE*	COMMON NAME	MAJOR STREET	LOCAL STREET	PEDESTRIAN STREET	PATIO / PLAZA	COURTYARD	PARKING LOT	ENTRYWAY
OLD TOWN continued									
SMALL TREES									
<i>Eucalyptus erythrocorys</i>	✓	Red Cap Gum		●	●	●			
<i>Lysiloma thornberi</i>	✓	Fern Of The Desert		●	●	●		●	
<i>Sophora secundiflora</i>	✓	Texas Mountain Laurel		●	●	●	●		
MEDIUM TREES									
<i>Acacia smalli</i>	✓	Sweet Acacia	●	●		●		●	
<i>Acacia stenophylla</i>	✓	Shoestring Acacia		●	●				
<i>Cercidium parkinsonia Hybrid</i>	✓	Desert Museum		●				●	
<i>Chorisa speciosa</i>	✓	Floss Silk Tree				●	●		
<i>Eucalyptus spatulata</i>	✓	Narrow-Leaf Gimlet	●	●	●	●			
<i>Eucalyptus torquata</i>	✓	Coral Gum			●	●	●		
<i>Geijera parviflora</i>	✓	Australian Willow			●	●	●		
LARGE TREES									
<i>Jacaranda mimosifolia</i>	✓	Jacaranda			●	●	●		
<i>Ulmus parvifolia</i>	✓	Evergreen Elm	●	●	●	●		●	
<i>Washingtonia robusta</i>	✓	Mex. Fan Palm	●						
MAIN STREET									
GROUNDCOVERS, VINES & OTHER									
<i>Agave murpheyi</i>	✓	Murphy's Agave		●	●	●			
<i>Agave weberii</i>	✓	Weber's Agave	●	●					
<i>Aloe</i>	✓	Blue Elf		●	●	●	●		
<i>Aloe dawei</i>	✓	Dawe's Aloe		●	●	●	●		
<i>Antigonon leptopus</i>	✓	Coral Vine/Queen's Wreath				●	●		
<i>Dasyllirion wheeleri</i>	✓	Desert Spoon	●	●					
<i>Gazania hybrids</i>	✓	Harlequin Hybrids		●	●	●			
<i>Lantana montevidensis</i>	✓	Trailing Lantana	●	●	●	●	●	●	
<i>Opuntia basilaris</i>	✓	Beaver Tail Prickly Pear	●	●	●				
<i>Opuntia santa-rita</i>	✓	Purple Prickly Pear	●	●	●				
<i>Podranea ricasoliana</i>	✓	Pink Trumpet Vine				●	●		
<i>Yucca recurvata</i>	✓				●	●	●		



Appendix 8-1A

RECOMMENDED PLANTS FOR DOWNTOWN

*Plants listed on Arizona Department of Water Resources lists of native, drought tolerant and low water-use plants, trees and shrubs.

BOTANICAL NAME	LOW WATER USE*	COMMON NAME	MAJOR STREET	LOCAL STREET	PEDESTRIAN STREET	PATIO / PLAZA	COURTYARD	PARKING LOT	ENTRYWAY
MAIN STREET continued									
SHRUBS									
<i>Asclepias subulata</i>	✓	Desert Milkweed		●	●	●			
<i>Caesalpinia mexicana</i>	✓	Mexican Bird of Paradise	●	●	●				
<i>Dalea frutescens</i>	✓	Black Dalea	●	●		●			
<i>Dalea pulchra</i>	✓	Bush Dalea	●	●				●	
<i>Encelia farinosa</i>	✓	Brittlebush	●	●	●			●	
<i>Guaiacum coulteri</i>	✓	Guayacan	●	●	●	●		●	
<i>Justica candicans</i>	✓	Red Justicia	●	●	●	●	●	●	
<i>Lantana</i>	✓	Red/Pink Forms		●	●				
<i>Maytenus phyllanthoides</i>	✓	Mangle Dulce	●	●	●			●	
<i>Ruellia brittoniana</i>	✓	Ruellia 'Katie' Pink/White Forms		●	●	●			
<i>Salvia clevelandii</i>	✓	Cleveland Sage	●	●	●			●	
<i>Simmondsia chinensis</i>	✓	Jojoba	●	●	●	●		●	
<i>Tecoma stans</i>	✓	Yellow Bells		●	●	●	●		
SMALL TREES									
<i>Caesalpinia mexicana</i>	✓	Mexican Bird of Paradise		●	●	●	●		
<i>Caesalpinia platyloba</i>	✓	Palo Colorado		●	●	●	●		
<i>Chamaerops humilis</i>	✓	Med. Fan Palm				●	●		
<i>Eucalyptus erythrocorys</i>	✓	Red Cap Gum		●	●	●			
<i>Lysiloma thornberi</i>	✓	Fern of the Desert		●	●	●		●	
<i>Sophora secundiflora</i>	✓	Texas Mountain Laurel		●	●	●	●		
MEDIUM TREES									
<i>Acacia smalli</i>	✓	Sweet Acacia	●	●		●		●	
<i>Cercidium Parkinsonia Hybrid</i>	✓	Desert Museum		●				●	
<i>Chorisa speciosa</i>	✓	Floss Silk Tree				●	●		
<i>Eucalyptus spatulata</i>	✓	Narrow Leaf Gimlet	●	●	●	●			
<i>Eucalyptus torquata</i>	✓	Coral Gum			●	●	●		
<i>Geijera parviflora</i>	✓	Australian Willow			●	●	●		
LARGE TREES									
<i>Jacaranda mimosifolia</i>		Jacaranda			●	●	●		
<i>Ulmus parvifolia</i>	✓	Evergreen Elm	●	●	●	●		●	
<i>Washingtonia robusta</i>	✓	Mexican Fan Palm	●						



Appendix 8-1A

RECOMMENDED PLANTS FOR DOWNTOWN

*Plants listed on Arizona Department of Water Resources lists of native, drought tolerant and low water-use plants, trees and shrubs.									
BOTANICAL NAME	LOW WATER USE*	COMMON NAME	MAJOR STREET	LOCAL STREET	PEDESTRIAN STREET	PATIO / PLAZA	COURTYARD	PARKING LOT	ENTRYWAY
FIFTH AVENUE									
GROUNDCOVERS, VINES & OTHER									
<i>Aloe ferox</i>	✓	Cape Aloe		●	●	●	●		
<i>Aloe marlothii</i>	✓	Aloe Berger		●	●	●	●		
<i>Antigonon leptopus</i>	✓	Coral Vine/Queen's Wreath				●	●		
<i>Aquilegia chrysantha</i>		Golden Columbine		●	●	●			
<i>Dasyllirion wheeleri</i>	✓	Desert Spoon	●	●					
<i>Gazania hybrids</i>	✓	Harlequin Hybrids		●	●	●			
<i>Lantana montevidensis</i>	✓	Trailing Lantana	●	●	●	●	●	●	
<i>Podranea ricasoliana</i>	✓	Pink Trumpet Vine				●	●		
<i>Wedelia trilobata</i>	✓	Yellow Dot		●	●				
<i>Yucca elephantipes</i>		Spineless Yucca	●	●	●			●	
<i>Yucca recurvata</i>	✓				●	●	●		
SHRUBS									
<i>Bougainvillea</i>	✓	Bush Types		●	●	●	●		
<i>Cordia parviflora</i>	✓	Little Leaf Cordia		●	●		●		
<i>Dalea capitata</i>	✓	Golden Dalea		●	●	●	●		●
<i>Guaiacum coulteri</i>	✓	Guayacan	●	●	●	●		●	
<i>Lantana</i>	✓	Red/Pink Forms		●	●				
<i>Maytenus phyllanthoides</i>	✓	Mangle Dulce	●	●	●			●	
<i>Mulhenbergia capillaris</i>	✓	Pink Mulhy/Gulf Mulhy	●	●	●	●		●	
<i>Muhlenbergia emersleyi</i>	✓	Bull Grass	●	●	●	●		●	
<i>Muhlenbergia rigens</i>		Deer Grass		●	●			●	
<i>Salvia clevelandii</i>	✓	Cleveland Sage	●	●	●			●	
<i>Senna phyllodemia</i>	✓	Silver-Leaf Cassia		●	●	●			
<i>Simmondsia chinensis</i>	✓	Jobba	●	●	●	●		●	
<i>Tecoma stans</i>	✓	Yellow Bells		●	●	●	●		
SMALL TREES									
<i>Acacia willardiana</i>	✓	Palo Blanco			●	●	●		
<i>Bauhinia blakeana</i>		Orchid Tree				●	●		
<i>Caesalpinia platyloba</i>	✓	Palo Colorado		●	●	●	●		
<i>Chamaerops humilis</i>	✓	Med. Fan Palm				●	●		
<i>Lysiloma thornberi</i>	✓	Fern Of The Desert		●	●	●		●	
<i>Sophora secundiflora</i>	✓	Texas Mountain Laurel		●	●	●	●		



RECOMMENDED PLANTS FOR DOWNTOWN

*Plants listed on Arizona Department of Water Resources lists of native, drought tolerant and low water-use plants, trees and shrubs.

BOTANICAL NAME	LOW WATER USE*	COMMON NAME	MAJOR STREET	LOCAL STREET	PEDESTRIAN STREET	PATIO / PLAZA	COURTYARD	PARKING LOT	ENTRYWAY
FIFTH AVENUE continued									
MEDIUM TREES									
<i>Cercidium Parkinsonia Hybrid</i>	✓	Desert Museum		●				●	
<i>Chorisa speciosa</i>	✓	Floss Silk Tree				●	●		
<i>Eucalyptus spatulata</i>	✓	Narrow-Leaf Gimlet	●	●	●	●			
<i>Eucalyptus torquata</i>	✓	Coral Gum			●	●	●		
<i>Geijera parviflora</i>	✓	Australian Willow			●	●	●		
LARGE TREES									
<i>Dalbergia sisso</i>	✓	Sissoo Tree	●	●	●			●	
<i>Eucalyotus citriodora</i>	✓	Lemon Scented Gum	●	●	●	●		●	
<i>Eucalyptus salmonoploia</i>	✓	Salmon Gum	●	●	●				
<i>Jacaranda mimosifolia</i>		Jacaranda			●	●	●		
<i>Ulmus parvifolia</i>	✓	Evergreen Elm	●	●	●	●		●	
<i>Washingtonia robusta</i>	✓	Mex. Fan Palm	●						
MARSHALL WAY									
GROUNDCOVERS, VINES & OTHER									
<i>Aloe ferox</i>	✓	Cape Aloe		●	●	●	●		
<i>Aloe marlothii</i>	✓	A. Berger		●	●	●	●		
<i>Antigonon leptopus</i>	✓	Coral Vine/Queen's Wreath				●	●		
<i>Dasyilirion wheeleri</i>	✓	Desert Spoon	●	●					
<i>Gazania hybrids</i>	✓	Harlequin Hybrids		●	●	●			
<i>Lantana montevidensis</i>	✓	Trailing Lantana	●	●	●	●	●	●	
<i>Podranea ricasoliana</i>	✓	Pink Trumpet Vine				●	●		
<i>Yucca recurvata</i>	✓				●	●	●		
SHRUBS									
<i>Bougainvillea</i>	✓	Bush Types		●	●	●	●		
<i>Convolvulus cneorum</i>	✓	Bush Morning Glory	●	●	●	●	●	●	
<i>Eremophila maculata</i>	✓	Emu Bush-Valentine		●	●	●			
<i>Guaiacum coulteri</i>	✓	Guayacan	●	●	●	●		●	
<i>Justica sonorae</i>	✓	Sonoran Honeysuckle		●	●	●			
<i>Maytenus phyllanthoides</i>	✓	Mangle Dulce	●	●	●			●	
<i>Poliomintha maderensis</i>		Mexican Oregano, Lavender Spice		●	●				



Appendix 8-1A

RECOMMENDED PLANTS FOR DOWNTOWN

*Plants listed on Arizona Department of Water Resources lists of native, drought tolerant and low water-use plants, trees and shrubs.									
BOTANICAL NAME	LOW WATER USE*	COMMON NAME	MAJOR STREET	LOCAL STREET	PEDESTRIAN STREET	PATIO / PLAZA	COURTYARD	PARKING LOT	ENTRYWAY
MARSHALL WAY continued									
SHRUBS continued									
<i>Salvia clevelandii</i>	✓	Cleveland Sage	●	●	●			●	
<i>Simmondsia chinensis</i>	✓	Joboba	●	●	●	●		●	
<i>Tecoma stans</i>	✓	Yellow Bells		●	●	●	●		
SMALL TREES									
<i>Acacia willardiana</i>	✓	Palo Blanco			●	●	●		
<i>Bauhinia blakeana</i>		Orchid Tree				●	●		
<i>Caesalpinia platyloba</i>	✓	Palo Colorado		●	●	●	●		
<i>Chamaerops humilis</i>	✓	Med. Fan Palm				●	●		
<i>Lysiloma thornberi</i>	✓	Fern Of The Desert		●	●	●		●	
<i>Sophora secundiflora</i>	✓	Texas Mountain Laurel		●	●	●	●		
MEDIUM TREES									
<i>Cercidium parkinsonia hybrid</i>	✓	Desert Museum		●				●	
<i>Chorisa speciosa</i>	✓	Floss Silk Tree				●	●		
<i>Eucalyptus spatulata</i>	✓	Narrow-Leaf Gimlet	●	●	●	●			
<i>Eucalyptus torquata</i>	✓	Coral Gum			●	●	●		
<i>Geijera parviflora</i>	✓	Australian Willow			●	●	●		
LARGE TREES									
<i>Dalbergia sisso</i>	✓	Sissoo Tree	●	●	●			●	
<i>Eucalyptus citriodora</i>	✓	Lemon Scented Gum	●	●	●	●		●	
<i>Eucalyptus salmonoploia</i>	✓	Salmon Gum	●	●	●				
<i>Jacaranda mimosifolia</i>		Jacaranda			●	●	●		
<i>Ulmus parvifolia</i>	✓	Evergreen Elm	●	●	●	●		●	
<i>Washingtonia robusta</i>	✓	Mexican Fan Palm	●						
DRINKWATER BOULEVARD									
GROUNDCOVERS, VINES & OTHER									
<i>Dasyllirion longissima</i>	✓	Mexican Grass Tree	●	●					
<i>Hesperaloe parviflora</i>	✓	Red Yucca	●	●	●	●		●	
<i>Lotus berthelotii</i>	✓	Parrot's Beak	●	●	●	●			
<i>Nolina matapensis</i>	✓	Tree Bear Grass	●	●					
<i>Oenothera berlandieri</i>	✓	Mexican Evening Primrose	●	●	●	●	●	●	
<i>Penstemon spp.</i>	✓	Bearded Tongue	●	●	●			●	



RECOMMENDED PLANTS FOR DOWNTOWN

*Plants listed on Arizona Department of Water Resources lists of native, drought tolerant and low water-use plants, trees and shrubs.

BOTANICAL NAME	LOW WATER USE*	COMMON NAME	MAJOR STREET	LOCAL STREET	PEDESTRIAN STREET	PATIO / PLAZA	COURTYARD	PARKING LOT	ENTRYWAY
DRINKWATER BOULEVARD continued									
GROUNDCOVERS, VINES & OTHER continued									
<i>Verbena rigida</i>	✓	Sandpaper Rigida	●	●	●				
<i>Yucca rupicola</i>	✓	Twisted Yucca	●	●	●			●	
SHRUBS									
<i>Bougainvillea</i>	✓	Bush Types		●	●	●	●		
<i>Caesalpinia pulcherimma</i>	✓	Red Bird Of Paradise	●	●	●	●		●	
<i>Cordia parviflora</i>	✓	Little-Leaf Cordia		●	●		●		
<i>Dalea pulchra</i>	✓	Bush Dalea	●	●				●	
<i>Lantana camara</i>	✓	Lantana, Shrub Verbena	●	●	●	●	●	●	
<i>Leucophyllum langmaniae</i>	✓	Cinnamon Sage	●	●	●			●	
<i>Ruellia peninsularis</i>	✓	Baja Ruellia	●	●	●	●		●	
<i>Salvia leucantha</i>	✓	Purple Mexican Bush Sage			●	●	●		
<i>Tecoma</i>	✓	Organ Jubilee		●	●	●	●		
SMALL TREES (none)									
MEDIUM TREES									
<i>Prosopis alba</i>	✓	Argentine Mesquite	●	●	●			●	
<i>Prosopis chilensis</i>	✓	Chilean Mesquite	●	●	●			●	
<i>Prosopis glandulosa</i>	✓	Honey Mesquite	●	●	●			●	
LARGE TREES									
<i>Eucalyotus citriodora</i>	✓	Lemon Scented Gum	●	●	●	●		●	
<i>Eucalyptus papuana</i>	✓	Ghost Gum	●	●	●			●	
<i>Eucalyptus salmonoploia</i>	✓	Salmon Gum	●	●	●				
<i>Phoenix dactylifera</i>	✓	Date Palm	●						
<i>Washingtonia filifera</i>	✓	California Fan Palm	●						
GOLDWATER BOULEVARD									
GROUNDCOVERS, VINES & OTHER									
<i>Baileya multiradiata</i>	✓	Desert Marigold	●	●	●			●	
<i>Dasyllirion acrotriche</i>	✓	Green Desert Spoon	●	●					
<i>Hesperaloe parviflora</i>	✓	Red Yucca	●	●	●	●		●	
<i>Yucca aloifolia</i>	✓	Spanish Bayonet			●	●	●		
<i>Yucca baccata</i>	✓	Banana Yucca	●	●				●	



Appendix 8-1A

RECOMMENDED PLANTS FOR DOWNTOWN

*Plants listed on Arizona Department of Water Resources lists of native, drought tolerant and low water-use plants, trees and shrubs.									
BOTANICAL NAME	LOW WATER USE*	COMMON NAME	MAJOR STREET	LOCAL STREET	PEDESTRIAN STREET	PATIO / PLAZA	COURTYARD	PARKING LOT	ENTRYWAY
GOLDWATER BOULEVARD continued									
SHRUBS									
<i>Caesalpinia pulcherimma</i>	✓	Red Bird Of Paradise	●	●	●	●		●	
<i>Calliandra californica</i>	✓	Baja Fairy Duster	●	●	●	●		●	
<i>Lantana camara</i>	✓	Lantana, Shrub Verbena	●	●	●	●	●	●	
<i>Leucophyllum langmaniae</i>	✓	Cinnamon Sage	●	●	●			●	
<i>Ruellia peninsularis</i>	✓	Baja Ruellia	●	●	●	●		●	
<i>Salvia leucantha</i>	✓	Purple Mexican Bush Sage			●	●	●		
<i>Tecoma</i>	✓	Organ Jubilee		●	●	●	●		
SMALL TREES (none)									
MEDIUM TREES									
<i>Prosopis alba</i>	✓	Argentine Mesquite	●	●	●			●	
<i>Prosopis chilensis</i>	✓	Chilean Mesquite	●	●	●			●	
<i>Prosopis glandulosa</i>	✓	Honey Mesquite	●	●	●			●	
LARGE TREES									
<i>Eucalyptus microtheca</i>	✓	Coolibah	●	●				●	
<i>Eucalyptus papuana</i>	✓	Ghost Gum	●	●	●			●	
<i>Phoenix dactylifera</i>	✓	Date Palm	●						
<i>Washingtonia filifera</i>	✓	California Fan Palm	●						
CAMELBACK ROAD									
GROUNDCOVERS, VINES & OTHER									
<i>Dalea greggii</i>	✓	Trailing Indigo Bush	●	●	●			●	
<i>Dasyliirion longissima</i>	✓	Mexican Grass Tree	●	●					
<i>Hesperaloe parviflora</i>	✓	Red Yucca	●	●	●	●		●	
<i>Lantana montevidensis</i>	✓	Trailing Lantana	●	●	●	●	●	●	
<i>Lotus berthelotii</i>	✓	Parrot's Beak	●	●	●	●			
<i>Nolina matapensis</i>	✓	Tree Bear Grass	●	●					
<i>Oenothera berlandieri</i>	✓	Mexican Evening Primrose	●	●	●	●	●	●	
<i>Penstemon spp.</i>	✓	Bearded Tongue	●	●	●			●	
<i>Verbena rigida</i>	✓	Sandpaper Rigida	●	●	●				
<i>Yucca rupicola</i>	✓	Twisted Yucca	●	●	●			●	



Appendix 8-1A

RECOMMENDED PLANTS FOR DOWNTOWN

*Plants listed on Arizona Department of Water Resources lists of native, drought tolerant and low water-use plants, trees and shrubs.									
BOTANICAL NAME	LOW WATER USE*	COMMON NAME	MAJOR STREET	LOCAL STREET	PEDESTRIAN STREET	PATIO / PLAZA	COURTYARD	PARKING LOT	ENTRYWAY
CAMELBACK ROAD continued									
SHRUBS									
<i>Calliandra californica</i>	✓	Baja Fairy Duster	●	●	●	●		●	
<i>Dalea pulchra</i>	✓	Bush Dalea	●	●				●	
<i>Leucophyllum candidum</i>	✓	Violet Silverleaf	●	●	●				
<i>Tecoma stans</i>	✓	Yellow Bells		●	●	●	●		
SMALL TREES									
<i>Bauhinia lunarioides</i> or <i>Bauhinia congesta</i>	✓	Chihuahuan Orchid Shrub		●	●	●	●		
<i>Eucalyptus erythrocorys</i>	✓	Red Cap Gum		●	●	●			
MEDIUM TREES									
<i>Acacia smalli</i>	✓	Sweet Acacia	●	●		●		●	
<i>Cercidium praecox</i> or <i>Parkinsonia praecox</i>	✓	Palo Brea	●	●	●			●	
<i>Eucalyptus spatulata</i>	✓	Narrow-Leaf Gimlet	●	●	●	●			
<i>Eucalyptus torquata</i>	✓	Coral Gum			●	●	●		
<i>Prosopis alba</i>	✓	Argentine Mesquite	●	●	●			●	
<i>Prosopis chilensis</i>	✓	Chilean Mesquite	●	●	●			●	
<i>Prosopis glandulosa</i>	✓	Honey Mesquite	●	●	●			●	
LARGE TREES									
<i>Eucalyptus microtheca</i>	✓	Coolibah	●	●				●	
<i>Jacaranda mimosifolia</i>		Jacaranda			●	●	●		
<i>Phoenix dactylifera</i>	✓	Date Palm	●						
<i>Washingtonia robusta</i>	✓	Mex. Fan Palm	●						
SCOTTSDALE ROAD									
GROUNDCOVERS, VINES & OTHER									
<i>Dasyllirion longissima</i>	✓	Mexican Grass Tree	●	●					
<i>Hesperaloe parviflora</i>	✓	Red Yucca	●	●	●	●		●	
<i>Lotus berthelotii</i>	✓	Parrot's Beak	●	●	●	●			
<i>Nolina matapensis</i>	✓	Tree Bear Grass	●	●					
<i>Penstemon spp.</i>	✓	Bearded Tongue	●	●	●			●	
<i>Verbena rigida</i>	✓	Sandpaper Rigida	●	●	●				
<i>Yucca rupicola</i>	✓	Twisted Yucca	●	●	●			●	



Appendix 8-1A

RECOMMENDED PLANTS FOR DOWNTOWN

*Plants listed on Arizona Department of Water Resources lists of native, drought tolerant and low water-use plants, trees and shrubs.									
BOTANICAL NAME	LOW WATER USE*	COMMON NAME	MAJOR STREET	LOCAL STREET	PEDESTRIAN STREET	PATIO / PLAZA	COURTYARD	PARKING LOT	ENTRYWAY
SCOTTSDALE ROAD continued									
SHRUBS									
<i>Guaiacum coulteri</i>	✓	Guayacan	●	●	●	●		●	
<i>Leucophyllum candidum</i>	✓	Violet Silverleaf	●	●	●				
SMALL TREES									
<i>Bauhinia lunarioides</i> or <i>Bauhinia congesta</i>	✓	Chihuahuan Orchid Shrub		●	●	●	●		
<i>Caesalpinia platyloba</i>	✓	Palo Colorado		●	●	●	●		
MEDIUM TREES									
<i>Acacia smallii</i>	✓	Sweet Acacia	●	●		●		●	
<i>Cercidium Parkinsonia Hybrid</i>	✓	Desert Museum		●				●	
<i>Cercidium praecox</i> or <i>Parkinsonia praecox</i>	✓	Palo Brea	●	●	●			●	
<i>Prosopis alba</i>	✓	Argentine Mesquite	●	●	●			●	
<i>Prosopis chilensis</i>	✓	Chilean Mesquite	●	●	●			●	
<i>Prosopis glandulosa</i>	✓	Honey Mesquite	●	●	●			●	
LARGE TREES									
<i>Eucalyptus microtheca</i>	✓	Coolibah	●	●				●	
<i>Eucalyptus papuana</i>	✓	Ghost Gum	●	●	●			●	
<i>Washingtonia robusta</i>	✓	Mexican Fan Palm	●						
INDIAN SCHOOL ROAD									
GROUNDCOVERS, VINES & OTHER									
<i>Baileya multiradiata</i>	✓	Desert Marigold	●	●	●			●	
<i>Dalea greggii</i>	✓	Trailing Indigo Bush	●	●	●			●	
<i>Dasyliiron acrotriche</i>	✓	Green Desert Spoon	●	●					
<i>Hesperaloe parviflora</i>	✓	Red Yucca	●	●	●	●		●	
<i>Penstemon spp.</i>	✓	Bearded Tongue	●	●	●			●	
<i>Yucca aloifolia</i>	✓	Spanish Bayonet			●	●	●		
<i>Yucca baccata</i>	✓	Banana Yucca	●	●				●	
SHRUBS									
<i>Cordia parviflora</i>	✓	Little-Leaf Cordia		●	●		●		
<i>Leucophyllum candidum</i>	✓	Violet Silverleaf	●	●	●				
<i>Ruellia peninsularis</i>	✓	Baja Ruellia	●	●	●	●		●	
<i>Salvia leucantha</i>	✓	Purple Mexican Bush Sage			●	●	●		
<i>Tecoma stans</i>	✓	Yellow Bells		●	●	●	●		
<i>Tecoma</i>	✓	Organ Jubilee		●	●	●	●		



RECOMMENDED PLANTS FOR DOWNTOWN

*Plants listed on Arizona Department of Water Resources lists of native, drought tolerant and low water-use plants, trees and shrubs.									
BOTANICAL NAME	LOW WATER USE*	COMMON NAME	MAJOR STREET	LOCAL STREET	PEDESTRIAN STREET	PATIO / PLAZA	COURTYARD	PARKING LOT	ENTRYWAY
INDIAN SCHOOL ROAD continued									
SMALL TREES									
<i>Acacia ridigula</i>	✓	Blackbrush Acacia	●	●				●	
<i>Caesalpinia platyloba</i>	✓	Palo Colorado		●	●	●	●		
<i>Lysiloma thornberi</i>	✓	Fern Of The Desert		●	●	●		●	
MEDIUM TREES									
<i>Acacia smalli</i>	✓	Sweet Acacia	●	●		●		●	
<i>Cercidium praecox</i> or <i>Parkinsonia praecox</i>	✓	Palo Brea	●	●	●			●	
<i>Eucalyptus spatulata</i>	✓	Narrow-Leaf Gimlet	●	●	●	●			
<i>Eucalyptus torquata</i>	✓	Coral Gum			●	●	●		
<i>Prosopis alba</i>	✓	Argentine Mesquite	●	●	●			●	
<i>Prosopis chilensis</i>	✓	Chilean Mesquite	●	●	●			●	
<i>Prosopis glandulosa</i>	✓	Honey Mesquite	●	●	●			●	
LARGE TREES									
<i>Dalbergia sisso</i>	✓	Sissoo Tree	●	●	●			●	
<i>Eucalyptus papuana</i>	✓	Ghost Gum	●	●	●			●	
<i>Washingtonia filifera</i>	✓	California Fan Palm	●						
<i>Washingtonia robusta</i>	✓	Mexican Fan Palm	●						